



ZGARD™ CX

Programmable Controller

Instruction Manual

WARNING

THIS MANUAL MUST BE CAREFULLY READ BY ALL INDIVIDUALS WHO HAVE OR WILL HAVE THE RESPONSIBILITY FOR INSTALLING, USING OR SERVICING THIS PRODUCT. Like any piece of complex equipment, this product will perform as designed only if installed, used and serviced in accordance with the manufacturer's instructions. OTHERWISE, IT COULD FAIL TO PERFORM AS DESIGNED AND PERSONS WHO RELY ON THIS PRODUCT FOR THEIR SAFETY COULD SUSTAIN SEVERE PERSONAL INJURY OR DEATH.

The warranties made by Mine Safety Appliances Company with respect to these Products are voided if the products are not installed, used and serviced in accordance with the instructions in this user guide. Please protect yourself and others by following them. We encourage our customers to write or call regarding this equipment prior to use or for any additional information relative to use or repair.

Instrument Division 1-800-MSA-INST or FAX (412) 776-9783

MSA International (412) 967-3228 or FAX (412) 967-3373

In Canada 1-800-267-0672 or FAX (905) 238-4155

© Mine Safety Appliances Company 1996 - All Rights Reserved

MINE SAFETY APPLIANCES COMPANY
PITTSBURGH, PENNSYLVANIA 15230

MSA Permanent Instrument Warranty

1. Warranty- Seller warrants that this product will be free from mechanical defect or faulty workmanship for a period of eighteen (18) months from date of shipment or one (1) year from installation, whichever occurs first, provided it is maintained and used in accordance with Seller's instructions and/or recommendations. This warranty does not apply to expendable or consumable parts whose normal life expectancy is less than one (1) year such as, but not limited to, non-rechargeable batteries, filament units, filter, lamps, fuses etc. The Seller shall be released from all obligations under this warranty in the event repairs or modifications are made by persons other than its own or authorized service personnel or if the warranty claim results from physical abuse or misuse of the product. No agent, employee or representative of the Seller has any authority to bind the Seller to any affirmation, representation or warranty concerning the product. Seller makes no warranty concerning components or accessories not manufactured by the Seller, but will pass on to the Purchaser all warranties of manufacturers of such components. **THIS WARRANTY IS IN LIEU OF ALL OTHER WARRANTIES, EXPRESSED, IMPLIED OR STATUTORY, AND IS STRICTLY LIMITED TO THE TERMS HEREOF. SELLER**

SPECIFICALLY DISCLAIMS ANY WARRANTY OF MERCHANTABILITY OR OF FITNESS FOR A PARTICULAR PURPOSE.

2. Exclusive Remedy- It is expressly agreed that Purchaser's sole and exclusive remedy for breach of the above warranty, for any tortious conduct of Seller, or for any other cause of action, shall be the repair and/or replacement at Seller's option, of any equipment or parts thereof, which after examination by Seller is proven to be defective. Replacement equipment and/or parts will be provided at no cost to Purchaser, F.O.B. Seller's Plant. Failure of Seller to successfully repair any nonconforming product shall not cause the remedy established hereby to fail of its essential purpose.

3. Exclusion of Consequential Damage- Purchaser specifically understands and agrees that under no circumstances will seller be liable to purchaser for economic, special, incidental or consequential damages or losses of any kind whatsoever, including but not limited to, loss of anticipated profits and any other loss caused by reason of non operation of the goods. This exclusion is applicable to claims for breach of warranty, tortious conduct or any other cause of action against seller.

General Warnings

WARNING

1. The ZGARD CX Programmable Controller described in this manual must be installed, operated, and maintained in strict accordance with the labels, cautions, warnings, instructions, and within the limitations stated.
2. The ZGARD CX Programmable Controller must not be installed in outdoor areas or in locations where explosive concentrations of combustible gases or vapors might occur in the atmosphere: Class 1, Group A, B, C, and D areas as defined by the NEC. Because the controller is not explosion-proof, it must be located in non-hazardous areas.
3. Do not paint the ZGARD CX Programmable Controller.
4. The only absolute method to assure the proper overall operation of a gas detection instrument is to check it with a known concentration of the gas for which it has been calibrated. Consequently, a calibration check must be included as part of the installation and as a routine inspection of the system.
5. Use only genuine MSA replacement parts when performing any maintenance procedures provided in this manual. Failure to do so may seriously impair instrument performance. Repair or alteration of the ZGARD CX Programmable Controller, beyond the scope of these maintenance instructions or by anyone other than authorized MSA service personnel, could cause the product to fail to perform as designed, and persons who rely on this product for their safety could sustain serious personal injury or death.
6. The ZGARD CX Programmable Controller must be installed, located and operated in accordance to all applicable codes. These codes include, but are not limited to, the National Fire Prevention Code and National Electric Code.
7. Do not exceed the relay contact ratings listed in this manual. Otherwise, the relay operation may fail, which can result in personal injury or death.

Failure to comply with the above warnings can result in serious personal injury or death.

Table of Contents

Section 1	General Information and Specifications	1.0
Section 2	General Installation Guidelines	2.0
Section 3	Factory Setup Configuration, Optional Remote Relay Modules	3.0
Section 4	Operation and Features	4.0
Section 5	Programmable Alarm Relays Operation	5.0
Section 6	Voting Feature & Operation	6.0
Section 7	LCD Screen Display Features , Start up routine, Home screen and Fail Status screen displays	7.0
	Stats features and example screen displays	7.1
	Warning, Zone and Alarm example screens displays	7.3
Section 8	Operation & Configuration Set Up Menu , Auto-Configuration	8.0
	Auto-Configuration continued	8.1
	Auto-Configuration continued, Warning and Alarm setup	8.2
	Zone, Voting and Warning relays assignment setup	8.3
	Warning relays assignment continued and Alarm relay assignment setup	8.4
	Relay Latching, Rely operation, Warning off delay and Alarm off delay setup	8.5
	Sensor calibration display and Menu access code	8.6
Section 9	Start-Up Procedure	9.0
Section 10	Parts List	10.0
Drawings		
106960A	Enclosure	
106961A	Panel Layout / Connections	
106962A	Installation Outline	

Section 1
ZGARD CX Controller
General Information and Specifications

The ZGARD CX Controller is an advanced microprocessor-based monitoring system designed to interface with remote gas sensors and perform user configured control functions for surveillance, activate ventilation equipment, personnel alert or alarm indication. The controllers feature audible and visual status indicators with relay outputs. The controller will automatically detect the total number and type of the remote sensors, actively residing on the RS485 network. Additional remote relay modules can also be tagged on the communication bus, creating a control and surveillance gas alarm monitoring system.

The ZGARD CX Controller provides programmable operating parameters, which are organized by a menu interface keypad. Standard features include a large LCD Screen, audible-visual indication and relay contact outputs. The remote gas sensors are connected via RS485 serial communication ports managed by the ZGARD CX Controller, up to 40 sensors can be employed. The ZGARD CX Controller acting as the host governs the digital RS485 serial communication and automatically coordinates the remote devices. MSA ZGARD S or GS sensor-transmitters are available to detect a wide variety of gases including Carbon Monoxide, Carbon Dioxide, Nitrogen Dioxide, Refrigerants and Ammonia. This is accomplished by assigning the remote devices with an appropriate binary address.

OPERATING SPECIFICATIONS

Remote Sensor Input	RS485 digital data bus, 4-wire connection
Remote Sensor Power	24Vdc at 100mA / Input
Network Capacity	40 Remote Gas Sensors
Power Requirements	Standard, 120Vac, 50/60 Hz \pm 10% at 2.5 Amps Optional, 220Vac, 50/60 Hz \pm 10% at 1.25 Amps
Remote Sensor Power	24Vdc @ 100mA, maximum 40 MSA ZGARD S or GS Series Gas Sensors
Operating Temperature	-10° to 40°C (14° to 104°F)
Storage Temperature	-20° to 50°C (-4° to 122°F)
User Interface	Keypad on the front panel of the controller with menu driven operating parameters
Digital Display Screen	4 Line x 40 Character backlit LCD Screen displays the operating, alarm and fault diagnostic status of the system. The display is split in two display mode sections
Status Display	Common LED's for System OK-Green, Warning- Amber, Alarm-Red and Sensor Fail-Red
Network Communication	RS485, 4-wire serial communication for remote gas sensors and auxiliary modules
Auto-Configuration Feature	Digitally recognized remote devices (Sensors and Auxiliary Modules). Each device residing on the RS485 serial data bus shall be automatically assigned as a Node on the network
Alarm & Warning Set-points	Adjustable from 1 to 99% of operating range for each system sensor type
Number of Relays	12 standard programmable Warning and Alarm Relays, SPDT
Auxiliary Relays	1 common Fault Relay, SPDT, Normally Energized (Sensor Fail) 1 common Warning Relay, SPDT 1 common Alarm Relay, SPDT 1 common External Audible Relay, SPDT
Relay Contacts Rating	10 Amps 1/8 H.P., 125Vac. 6 Amps 1/8 H.P., 277Vac. 5 Amps, 30Vdc.
Relay Action	All programmable relays can be defined as Normally Energized or De-Energized and Latching or Non-Latching
Relay Time Delays	Menu selected OFF delays, adjustable from 0 to 600 seconds for Warning and Alarm, effectively common to all active channels
Set-up and Calibration	Pre-configured at factory or configurable by user
Audible Alarm	Audible Alarm Device, 93 dB @ 0.3 meters
Pushbutton	Alarm Reset and Silence feature
Remote Relay Modules (RRM)	Up to 7 OPTIONAL RRM'S can be coupled with the controller. Each relay module provides a complement of 16 relays that can be assigned with a function or mimic the operating parameters, directed by the host ZGARD CX Controller
Strobes Options	OPTIONAL flashing Strobes factory mounted on the top of the enclosure
Enclosure	Metal, NEMA 1
Dimensions	15" (381 mm) H x 12" (305 mm) W x 3.75" (95 mm) D
Weight	6.8kg (15 lbs.)
Certification	ENTELA (to CSA Standards)

Section 2

ZGARD CX Controller Installation Guidelines

The performance of ZGARD CX Controller is also dependent on the appropriate employment of the associated remote gas sensors. The remote gas sensors should be strategically placed closest to the areas where the target gases or vapors might occur in the atmosphere. Follow the recommended guidelines listed below.

Mounting:

- Do not mount the controller to structures subject to vibration and shock, such as piping and piping supports.
- Do not locate the controller near excessive heat source or in wet and damp locations.
- For proper cooling, allow at least five inches of clearance around all surfaces except for the mounting surface. Also consider mounting the controller so it can be easily accessed for service and routine testing.
- Make sure the controller is not blocked; otherwise front panel lights and controls will be obscured from view.
- The controller has four mounting lugs; securely mount the instrument to a wall or support using appropriate hardware.

Wiring Connections:

Before putting a ZGARD CX Controller into operation, determine the capacity, designation and number of remote gas sensors, and configure the controller according to the required application. Also refer to the ZGARD CX controller Installation Outline drawing located in the back of this manual, which provides important information regarding;

- Operating power.
- Number and type of remote sensors.
- Required conductors and wire size.
- Relay wiring connection.
- 4-20mA Output wiring connection.

CAUTION

1. When wiring the controller, disconnect the main power to prevent bodily harm.
2. Do not use the controller power when connecting any external devices to the relay contacts.
3. Use shielded cable for wiring installation. Do not install low voltage signal cable in the same conduit as the controller's operating power and or relay wiring.
4. Do not exceed the contact ratings marked on the relays.
5. Make sure that each sensor is given a unique address (Jumper selected), or the ZGARD CX Controller may not be able to communicate appropriately.
6. When connecting the remote sensors, make sure that all wiring is correct and the four leads of the RS485 bus are not interchanged, or permanent damage to the sensor may result.
7. Perform all wiring and conduit installation in accordance to the National Electrical Code.
8. The fuse at the input is a SloBlo type fuse and REPLACE FUSE ONLY WITH A FUSE WITH THE SAME RATING.

Failure to follow the above cautions can result in injury or property damage.

Section 3
ZGARD CX Controller
Factory Setup Configuration

Number of Remote Sensors	40 Sensors detected the by Auto-Configuration feature	
Operating Range	0 - 9999 (Auto-Ranging)	
Warning Level	25% FS	
Alarm Level	50% FS	
Relay Assignment		
K1 -Fixed non-adjustable	System Fault Condition	Assigned to all identified Sensors
K2 User Defined *	Common Warning Level	Assigned to all identified Sensors
K3 User Defined **	Common External Audible	Assigned to all identified Sensors
K4 User Defined ***	Common Alarm Level	Assigned to all identified Sensors
K5	Programmable	User Defined
K6	Programmable	User Defined
K7	Programmable	User Defined
K8	Programmable	User Defined
K9	Programmable	User Defined
K10	Programmable	User Defined
K11	Programmable	User Defined
K12	Programmable	User Defined
K13	Programmable	User Defined
K14	Programmable	User Defined
K15	Programmable	User Defined
K16	Programmable	User Defined
K17	Programmable	User Defined
K18	Programmable	User Defined
K19	Programmable	User Defined
K20	Programmable	User Defined
K21	Programmable	User Defined
K22	Programmable	User Defined
K23	Programmable	User Defined
K24	Programmable	User Defined
K25	Programmable	User Defined
K26	Programmable	User Defined
K27	Programmable	User Defined
K28	Programmable	User Defined
K29	Programmable	User Defined
K30	Programmable	User Defined
K31	Programmable	User Defined
K32	Programmable	User Defined
Relay Mode	K2* and K4*** Latching or Non-Latching, Energized or De-Energized K3** Energized or De-Energized K1 Non-Adjustable, Normally Energized (Fail Safe)	
Time Delays	Set to 10 seconds for Alarm & Warning, common to all identified remote sensors	

Optional Remote Relay Modules (RRM): With an optional Remote Relay Module, an addition of 16 relays (K17 to K32) can be supplemented providing a total programmable capacity of 28. A full compliment of Remote Relay Modules (RRM) can facilitate up to 96 relays that mimic the actions of relays K5 to K32. Each RRM is coupled on the RS485 network and can reside anywhere on the data bus, up to 1,500 meters away from the controller. The ZGARD CX Controller also provides the 24Vdc operating power for the RRM's. Some applications may require the aid of a Power and Signal Booster.

REMOTE RELAY MODULE SPECIFICATIONS

Operating Power	24Vdc, powered by host controller
Network Communication	RS485, 4-wire serial communication
Temperature	Operating: -10° to 40°C (14° to 104°F) Storage: -20° to 50°C (-4° to 122°F)
Relay Action	Relays mimic or function according to the pre-selected operating options concluded by the host controller, acting as the master
Relay Contacts Rating	10 Amps 1/8 H.P., 125Vac. 6 Amps 1/8 H.P., 277Vac. 5 Amps, 30Vdc.
Enclosure	Fiberglass NEMA 4 design
Dimensions	11.5" (292 mm) H x 9.5" (241 mm) W x 4.75" (121 mm) D
Certification	ENTELA (to CSA Standards)

Section 4

ZGARD CX Controller Operation and Features

Auto Configuration: The ZGARD CX Controller will automatically recognize the number of remote gas sensors that are compliant with the system. The first screen on the configuration setup menu prompts the user to decide if the Auto-Configuration program should be executed. There are 3 options to choose from. The Full Configuration... finds sensors and sets all parameters to defaults including relay assignments. The Add Sensors... finds new sensors beyond the last active sensor in the system. The Change Sensors... compares the gas identification codes of all active sensors and reconfigures the sensors with the new association. When either option is chosen, the controller will start searching for the remote gas sensors residing on the RS485 data bus network and organizes the system accordingly.

Programmable Configuration: The Keypad on the front panel permits the user to program the controller for customized applications. To prevent unauthorized access, an entry code must be entered before the configuration mode is offered.

Remote Sensors: The controller is designed to host a series of MSA ZGARD S or GS gas sensors with RS485 digital output. These sensors are supported on a 4-wire data bus (network). Each sensor facilitates Address Jumpers used to assign a digital address code.

Warning Condition: If the gas level measured at any of the remote sensors or group of sensors exceeds a predetermined warning threshold, then

the common Warning LED located above the LCD Screen will indicate a warning event. Relay outputs can be pre-assigned to activate on the Warning level.

Alarm Condition: If the gas level measured at any of the remote sensors or group of sensors exceeds a predetermined alarm threshold, then the common Alarm LED located above the LCD Screen will indicate an alarm event. The audible alarm will also sound at this time, pressing the reset button during an Alarm event will silence the audible device. If a new Alarm should occur while the gas controller is already in an Alarm condition, the audible alarm will sound again; repeatedly pressing the reset button can silence it. Relay outputs can be pre-assigned to activate on the Alarm level.

Relay Mode: Each programmable Warning and Alarm relay can be configured to operate in the normally de-energized or normally energized, latching or non-latching mode and an OFF Delay.

System Diagnostics Feature: If any active remote device should fail to communicate on the RS485 network, the System OK LED will turn OFF and the fail relay will de-activate. Subject to a communication failure, the Warning LED will also turn ON and the warning relays will be activated. Considering that the warning level of a gas controller system is typically used as the ventilation index, this feature is provided as a fail-safe measure to ensure the surveillance-affected area is ventilated.

Section 5
ZGARD CX Controller
Programmable Alarm Relays Operation

Alarm and Control: There are two basic operating schemes that can be set up by the controller. The options described below can be selected by the user interface keypad located on the front panel.

- **Default Mode:** The program memory of the ZGARD CX controller retains the identification codes for MSA ZGARD S and GS gas sensors listed. Each sensor type and operating range includes pre-selected warning and alarm thresholds. For instance, if the ZGARD CX controller identifies ZGARD S and GS Carbon Monoxide sensor, then the option of using the internal codes is available. This feature will accept the residing threshold of 25ppm (Warning) and 50ppm (Alarm), and will be used to determine the alarm status commands reported by the controller during operation.
- **Custom Mode:** The ZGARD CX controller can be programmed with custom threshold settings. This option will bypass the internal digital identification code of a ZGARD S and GS sensor. The Warning and Alarm thresholds can be set to any value from 1% to 99% of the operating range (Full Scale) for each individual system sensor.

Zone Feature: When a group of remote sensors are to be assigned as Zone the user can select a control relay or set of relays to operate as group. The ZGARD CX controller will execute the function accordingly. This will determine the action when Warning and Alarm set points have been breached. The ZGARD CX controller can manage up to 9 discrete Zones.

Voting Feature: A Zone (group of remote sensors) can be directed by a Voting protocol. This feature associates a Zone and control relay or set of relays to execute instructions managed by a voting scheme. A voting number is selected as the trigger point, which is used to determine when a multiple of Warning set points have been breached. Choosing the voting number is a function of how many threshold levels have been breached within a Zone. **Refer to the VOTE OPERATION in Section 6 for further details.**

- **Relay Settings:** The controller provides a standard compliment of 12 user-defined alarm relay outputs, which can be assigned to a number of zones. An additional set of 16-relays can be added by employing a RRM Remote Relay Module providing a total capacity of 28 programmable relays. A full compliment of Remote Relay Modules provides up to 96 contacts that mimic the programmable functions of relays K5 to K32.
- **Relay Modes:** Relays set to function as normally de-energized are inactive under normal condition, and will be activated during a threshold breach. The normally energized function forces a relay to be powered ON during normal conditions and will de-activate during a threshold breach. This feature is known as a fail-safe operation. When a relay is activated, the LED located beside it will be turned ON. Relays set to the latching function will lock ON after a threshold breach. The reset button must be pressed after each condition has cleared in order to de-activate the relays.

Delay Feature: The Warning and Alarm relays can be set with an OFF delay between 0 to 600 seconds. The OFF delay is common to all of the gas sensors linked to the controller.

Section 6
ZGARD CX Controller
Voting Feature & Operation

Voting Application: Some applications necessitate a particular alarm and control criteria. Each application should be taken into account with the aid of the voting system. Perhaps some potentially low risk protected areas would not justify an alarm event until the consequences dictate a responsible criterion. Choosing the Voting number is application dependent.

The voting number 1 will allow any singular threshold breach to act immediately. The examples below will demonstrate how a voting event

functions. During the configuration of a vote assignment the controller will not allow the user to enter a number that is equal to or greater than the number of sensors in a zone. The highest Voting number for any zone (group of sensors) is 9.

For example, a group of 5 sensors are to be assigned to Zone 1 and the selected Voting number is 2. This is used to indicate the impending voting status for a zone. Therefore, at least 2 out of 5 Sensor thresholds must be breached.

Example: Shown below demonstrates how the voting system functions.

With only 1 Warning level condition present the voting system determines that a Warning status or relay output action does not meet the voting criteria.				
EVENT A	Zone 1	Threshold Breaches	Controls & Indication	5 Gas Sensors allocated for a given area. 2 out of 5 Sensor thresholds must be breached.
Warning Level % FS	25	1	Normal	Common Warning Status
Alarm Level % FS	50			
Zone Event				No Controls & Indication
System	OK		NORMAL	Resultant Threshold

When a second Warning level is breached in the same zone then the voting system determines that the voting criterion has been established. The resultant is a Warning status and relay action.				
EVENT B	Zone 1	Threshold Breaches	Controls & Indication	5 Gas Sensors allocated for a given area. 2 out of 5 Sensor thresholds must be breached.
Warning Level % FS	25	2	Warning LED	Common Warning Status
Alarm Level % FS	50			
Zone Event		Warning Relay(s)		Warning Control & Indication
System	WA		WARNING	Resultant Threshold

Since 2 Warning and an Alarm level have been breached, the over all result is an Alarm status with both the Warning and Alarm relay activated.				
EVENT C	Zone 1	Threshold Breaches	Controls & Indication	5 Gas Sensors allocated for a given area. 2 out of 5 Sensor thresholds must be breached.
Warning Level % FS	25	2	Warning LED	Common Warning Status
Alarm Level % FS	50	1	Alarm LED	Common Alarm Status
Zone Event		Warning Relay(s)	Alarm Relay(s)	Warning and Alarm Control & Indication
System	AL		ALARM	Resultant Threshold

Section 7
ZGARD CX Controller
LCD Screen Display Feature

Once the ZGARD CX controller is powered ON, it will execute a 60 second start-up routine. The text on the display screen should read:



HOME Screen: The LCD is split into two sections separated by a column of "|". The **left side of the screen** exhibits the status of all of the active channels. The text message OK will be shown during normal operation. For visualisation, the screen is sequentially updated every 2 seconds.

1 :	1 0 P P M O K		Z O N E	# S N S	V O T E	S T A T U S
R G :	1 0 0 C O		1	4	0 / 2	O K
W :			2	4	0 / 2	O K
A :			3	0	0 / 1	O K

Column1-Line1: Starting with the first active channel the display reports the gas level and the concentration symbol, ppm (part per million) as an example. The **OK** status condition is displayed when the current polled system sensor is not in an alarm condition.

Column1-Line 2: Displays the descriptor **RG**, which symbolizes the operating range, of the current sensor being polled. The range and the sensor type are sequentially revealed on every update.

Column1-Line 3: Displays the descriptor **W**, which is the symbol for "Warning". If any sensor breaches its respective warning level, then the sensor number will be displayed adjacent to the W descriptor. If a number of sensors breach the warning status, then their respective number will appear and line up to the right of each other. Should the number of sensors in a warning condition exceed the physical space provided, then a "+" sign will be displayed at the end of the line.

Column1-Line 4: Displays the descriptor **A**, which is the symbol for "Alarm". If any one of the system sensors breach its respective alarm level, then the sensor number will be displayed adjacent to the A descriptor. If a number of sensors breach the alarm status, then their respective number will appear and line up to the right of each other. Should the number of sensors exceed the physical space provided, then a "+" sign will be displayed at the end of the line.

FAIL Status: Line 2 is also utilized by a second application. If any of the system sensors fail to operate, then a fault condition will occur. As the suspect sensor is polled, line 1 will display the text message "INVALID TYPE". Once a fail event is acknowledged by the system, the corresponding sensor number is held in cue. During this event the "Sensor Fail" LED on the top of the LCD Screen will turn ON. This is the first indication of a Fail condition. Now the operator has the opportunity to press the **STATS** button on the Keypad and conduct a diagnostic test. When the **STATS** button on the Keypad is momentarily pressed, the left segment of the screen will be changed to show the descriptor **F**. This line will now be used as a diagnostic display to register any system sensor that is in Fail mode. After the STATS key button on the Keypad is released, the left segment of the screen will return to the Home screen. A multi sensor failure occurrence will continue to fill in the line right of the **F** descriptor. Should the number of sensors exceed the physical space of the line provided, then a "+" sign will be displayed at the end of the line.

Example: The **STATS** display screen shown below is reporting that sensors 2 and 7 in Zone 1 are in a fail condition and the controller is currently polling sensor 2, exhibiting an INVALID TYPE status.

2 :	I N V A L I D T Y P E		Z O N E	# S N S	V O T E	S T A T U S
F :	2 7		1	4	0 / 2	W A R N.
W :			2	4	0 / 2	O K
A :			3	0	0 / 1	O K

Section 7
ZGARD CX Controller
LCD Screen Display Feature

The **right side of the LCD Screen** displays the Zone, #SNS, Vote and the Status of each zone (group of remote sensors) and is sequentially updated every 2 seconds.

Column1: The term **ZONE** reports the zone numbers.

Column2: The term **#SNS** reports the number of sensors allocated to the current Zone.

Column3: The term **VOTE** reports the voting number allocated to each zone and exhibits two numbers separated by a '/'. The first number is the number of votes the zone has received as a result of warning set point violations. This number can go as high as the number of sensors assigned to that zone (if all sensors should ever go to warning). The second number is the voting number, which has been defined during the configuration of the controller. At a glance, the user can view the progression of a warning condition in real time. If the left most number is equal to or greater than the right most number, then the voting criterion has been met and the system will go into warning condition.

Column4: The term **STATUS** reports and updates the condition of each zone. The symbol OK, Warn or Alarm may appear depending on the conditional events in each zone.

Example: ZGARD CX Home Screen.

1 :	1 0	PPM	OK	ZONE	# SNS	VOTE	STATUS
RG :	1 0 0	CO		1	3	0 / 2	OK
W :				2	5	0 / 2	OK
A :				3	4	0 / 1	OK

Example: ZGARD CX **STATUS** Display Screen. Shown below is an example of Zone 1 in Warning and Zone 3 in an Alarm condition.

1 :	3 5	PPM	WA	ZONE	# SNS	VOTE	STATUS
RG :	1 0 0	CO		1	3	2 / 2	WARN.
W :	1 2			2	5	0 / 2	OK
A :	9			3	4	1 / 1	ALARM

9 :	6 0	PPM	AL	ZONE	# SNS	VOTE	STATUS
RG :	1 0 0	CO		1	3	2 / 2	WARN.
W :	1 2			2	5	0 / 2	OK
A :	9			3	4	1 / 1	ALARM

Section 7
ZGARD CX Controller
LCD Screen Display Feature

Using the examples below the screen simulations demonstrate the following displays. A ZGARD CX has been configured with: 2 Zones, 4 Sensors per Zone, all Sensors are 100ppm CO type; Warning at 35ppm, Alarm at 50ppm and the Voting number is 2.

1. System OK

1 :	1 0	PPM	OK	ZONE	# SNS	VOTE	STATUS
RG :	1 0 0	CO		1	4	0 / 2	OK
W :				2	4	0 / 2	OK
A :				3	0	0 / 1	OK

2. Sensor 1=40ppm (warning), Zone 1 → OK because only one sensor in zone 1 is in warning.

1 :	4 0	PPM	WA	ZONE	# SNS	VOTE	STATUS
RG :	1 0 0	CO		1	4	1 / 2	OK
W :	1			2	4	0 / 2	OK
A :				3	0	0 / 1	OK

3. Sensor 1=40ppm (warning), 2=45ppm (warning), Zone 1 → WARNING because 2 Sensors in zone 1 are in warning and the relay(s) for zone 1 activates.

2 :	4 5	PPM	WA	ZONE	# SNS	VOTE	STATUS
RG :	1 0 0	CO		1	4	2 / 2	WARN.
W :	1 2			2	4	0 / 2	OK
A :				3	0	0 / 1	OK

4. Sensor 1=60ppm (alarm), 2=45ppm (warning), Zone 1 → ALARM because one or more sensors in zone 1 are in alarm, and the warning & alarm relay(s) for zone 1 activate.

1 :	6 0	PPM	AL	ZONE	# SNS	VOTE	STATUS
RG :	1 0 0	CO		1	4	2 / 2	ALARM
W :	2			2	4	0 / 2	OK
A :	1			3	0	0 / 1	OK

5. Sensor 1=60ppm (alarm), Zone 1 → ALARM because one or more sensors in zone 1 is in alarm, and the warning & alarm relay(s) for zone 1 activate.

1 :	6 0	PPM	AL	ZONE	# SNS	VOTE	STATUS
RG :	1 0 0	CO		1	4	1 / 2	ALARM
W :				2	4	0 / 2	OK
A :	1			3	0	0 / 1	OK

6. Sensor 2 Failed, Zone 1 → WARNING because one sensor has failed (failed sensor is forced into warning).

2 :	INVALID	TYPE		ZONE	# SNS	VOTE	STATUS
RG :	1 0 0	CO		1	4	0 / 2	WARN.
W :				2	4	0 / 2	OK
A :				3	0	0 / 1	OK

When the **STATS** button on the Keypad is momentarily pressed, the left segment of the screen will be changed to show the descriptor **F** as shown below. This line is used as a diagnostic display to register any system sensor that is in Fail mode.

3 :	0	PPM	OK	ZONE	# SNS	VOTE	STATUS
F :	2			1	4	0 / 2	WARN.
W :				2	4	0 / 2	OK
A :				3	0	0 / 1	OK

After the **STATS** key is released, the left segment of the screen will return to the Home screen.

4 :	0	PPM	OK	ZONE	# SNS	VOTE	STATUS
RG :	1 0 0	CO		1	4	0 / 2	WARN.
W :				2	4	0 / 2	OK
A :				3	0	0 / 1	OK

Section 8
ZGARD CX Controller
Operation & Configuration Set Up Menu

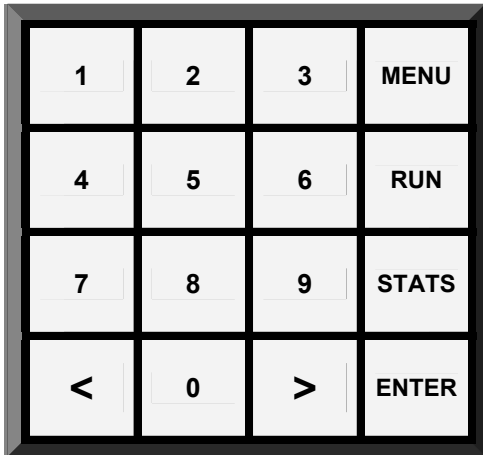

Before the ZGARD CX controller is ready to function, all of the operating parameters must be configured. The Keypad on the front panel provides the user to interface with the set-up Menu. To advance to any specific menu item keep pressing the MENU key repeatedly until the desired menu screen appears. The Keypad shown here is representative of the device mounted on the front panel.

⚠ CAUTION

During configuration, the controller will NOT supervise any sensor inputs. All relay actions are arrested and will NOT activate or deactivate even if the gas level at any of the system sensors should change.

TIME OUTS: In the absence of keypad activity, an automatic time-out will return the ZGARD CX controller to the RUN mode and then back to the Home Screen after 5 minutes. Similarly, during the Calibration Mode, the time-out is 30 minutes.

- I. **Press the MENU key. The controller will prompt the user to enter an access code.**
- II. Type in the access code followed by the ENTER key. The factory access code is recorded at the end of section 8 of this manual.



- III. **Press the MENU key.**
- IV. The **AUTO-CONFIG** menu will appear. The second line of the display shows the current setting NO, which is the default setting. The third line implies the programmer to change the setting. There are 3 options for the auto configuration program.



Option 1: The user may proceed with a **FULL CONFIGURATION**. This option will automatically configure the remote sensors that are appropriately connected to the system and assign them all to Zone 1. This is a default provision. The user may accept all of the found sensors already pre-assigned to Zone 1 followed by the verification of the Warning and Alarm set points. Once that has been completed, the sensors can be appointed to other zones and relay assignments depending on the required application.

Option 2: The user may **ADD SENSORS** to the system. This option allows the user to increase the number of sensors already on the system. However, this may only be conducted if the system has previously been auto-configured. This option will automatically assign all additional remote sensors to Zone 1 followed by the verification of the Warning and Alarm set points. The user may accept all of the newly found sensors pre-assigned to Zone 1 or may appoint to other zones and relay assignments depending on the required application.

Option 3: The **CHANGE SENSORS** option allows the user to modify any of the sensors that already exist on the system. The system will verify and change the sensor **TYPE & RANGE**. The user will be asked to verify the Warning and Alarm set points.

ZGARD CX Controller Operation & Configuration Set Up Menu

V. Press the → key.

A. **Full auto configuration:** The user may proceed with a full configuration.

```
AUTO - CONFIG : FULL CONFIGURATION
FIND & ASSIGN ALL SENSORS TO ZONE 1
< , > : CHANGE                               ENTER : ACCEPT
```

The screen below will appear as the remote sensors are found and verified. The example below demonstrates a system being configured with 24 remote sensors.

```
AUTO - CONFIG : SCANNING . . .
 1  2  3  4  5  6  7  8  9 10 11 12 13
< , > : CHANGE                               ENTER : ACCEPT
```

Should the system find more than the second line can facilitate, the scanning sequence will continue to fill in as they are found.

```
AUTO - CONFIG : SCANNING . . .
14 15 16 17 18 19 20 21 22 23 24
< , > : CHANGE                               ENTER : ACCEPT
```

B. The user may accept all of the found sensors already pre-assigned to Zone 1 and then will be asked to verify the Warning and Alarm set points. Press the menu key to accept and continue.

```
AUTO - CONFIG : 24 SENSORS FOUND
14 15 16 17 18 19 20 21 22 23 24
>>> VERIFY WARNING & ALARM SETPOINTS <<<
                                MENU : CONTINUE
```

VI. Press the → key.

A. **Add sensors auto-configuration:** The user may proceed to add sensors to the system.

```
AUTO - CONFIG : ADD SENSORS
FIND & ASSIGN NEW SENSORS TO ZONE 1
< , > : CHANGE                               ENTER : ACCEPT
```

B. The screen below will appear and report the number of new sensors that have been found. The user will be asked to verify the Warning and Alarm set points. Press the menu key to accept and continue.

```
AUTO - CONFIG :          3 SENSORS FOUND
25 26 27
>>> VERIFY WARNING & ALARM SETPOINTS <<<
                                MENU : CONTINUE
```

Section 8
ZGARD CX Controller
Operation & Configuration Set Up Menu

VII. Press the → key.

- A. **Change sensors auto configuration:** The user may now change the type and range for any existing sensors on the system.

```
AUTO - CONFIG : CHANGE SENSORS
VERIFY & CHANGE SENSOR TYPE & RANGE
< , > : CHANGE                               ENTER : ACCEPT
```

- B. The screen example below will appear and report that sensor 24 has been changed. The user will be asked to verify the Warning and Alarm set points. Press the menu key to accept and continue.

```
AUTO - CONFIG : SCANNING . . .
24
>>> VERIFY WARNING & ALARM SETPOINTS <<<
MENU : CONTINUE
```

VIII. Press the MENU key.

- IX. The **WARNING SETPOINT** menu will appear. The second line of the display shows the current sensor # to be assigned a warning set-point level. The sensor range is also shown for reference only. The third line shows the gas type and current set point. The following choices are available:

- A. **Change set point:** Type the new warning set point (cannot exceed the RANGE value shown) and press ENTER.
- B. **Go to next sensor #:** Press the ← or → key to move through all of the sensor numbers.

```
WARNING SETPOINT
SENSOR # : 1           RANGE : 100 PPM
SETPOINT : 25 PPM     GAS : CO
< , > : SENSOR 0 . . 9 : VALUE           ENTER : ACCEPT
```

X. Press the MENU key.

- XI. The **ALARM SETPOINT** menu will appear. The second line of the display shows the current sensor # to be assigned an alarm set-point level. The sensor range is also shown for reference only. The third line shows the gas type and current set point. The following choices are available:

- A. **Change set point:** Type the new alarm set point (cannot exceed the RANGE value shown) and press ENTER.
- B. **Go to next sensor #:** Press the ← or → key to move through all of the sensor numbers.

```
ALARM SETPOINT
SENSOR # : 1           RANGE : 100 PPM
SETPOINT : 50 PPM     GAS : CO
< , > : SENSOR 0 . . 9 : VALUE           ENTER : ACCEPT
```

ZGARD CX Controller Operation & Configuration Set Up Menu

XII. Press the MENU key.

XIII. The **ZONE ASSIGNMENT** menu will appear. The second line of the display shows the current sensor # to be assigned with the corresponding zone number. The following choices are available:

- A. **Change sensor #:** Press the ← or → key to associate the sensor # with the zone #.
- B. **Change zone #:** Type the new zone (1 to 9) number and press ENTER to accept.

```

ZONE ASSIGNMENT
  SENSOR # :      1           ZONE # :      1
< , > : SENSOR      1 . . 9 : ZONE           ENTER : ACCEPT

```

XIV. Press the MENU key.

XV. The **VOTING NUMBER** menu will appear. The second line of the display shows the current zone number to be assigned with the corresponding vote number. The following choices are available:

- A. **Change zone #:** Press the ← or → key to associate the zone # with the vote #.
- B. **Change voting #:** Type the new vote (1 to 9) number and press ENTER to accept.

```

VOTING NUMBER
  ZONE # :      1           VOTING # :      1
< , > : ZONE      1 . . 9 : VOTE           ENTER : ACCEPT

```

XVI. Press the MENU key.

The **WARNING RELAY ASSIGNMENT** menu will appear. The second line of the display shows the current warning relay number to be assigned with the corresponding zone #. **NOTE:** Relays 1 to 4 have default functions. The first relay that will appear after pressing the → key will be number 1, SYSTEM FAULT that is non-adjustable. As the user continues to press the → key the second relay, 2 COMMON WARNING will appear. The next relay, 3 EXTERNAL AUDIBLE and then relay 4, COMMON ALARM will appear.

```

WARNING RELAY ASSIGNMENT
  RELAY # :      1           SYSTEM FAULT
< , > : RELAY      0 . . 9 : ZONE           ENTER : ACCEPT

```

```

WARNING RELAY ASSIGNMENT
  RELAY # :      2           COMMON WARNING
< , > : RELAY      0 . . 9 : ZONE           ENTER : ACCEPT

```

```

WARNING RELAY ASSIGNMENT
  RELAY # :      3           EXTERNAL AUDIBLE
< , > : RELAY      0 . . 9 : ZONE           ENTER : ACCEPT

```

Section 8

ZGARD CX Controller

Operation & Configuration Set Up Menu

```

WARNING RELAY ASSIGNMENT
RELAY # : 4 COMMON ALARM
< , > : RELAY 0 . . 9 : ZONE ENTER : ACCEPT

```

XVII. When relay 5 is displayed, the system will allow the following choices:

- A. **Change zone #:** Type the new zone number and press ENTER.
- B. **Next relay number:** Press the ← or → key to move through all of the Warning relay assignments.

```

WARNING RELAY ASSIGNMENT
RELAY # : 5 ZONE # : NONE
< , > : RELAY 0 . . 9 : ZONE ENTER : ACCEPT

```

XVIII. Press the MENU key.

The **ALARM RELAY ASSIGNMENT** menu will appear. The second line of the display shows the current alarm relay number to be assigned with the corresponding zone #. **NOTE:** Relays 1 to 4 have default functions. The first relay that will appear after pressing the → key will be number 1, SYSTEM FAULT that is non-adjustable. As the user continues to press the → key the second relay, 2 COMMON WARNING will appear. The next relay, 3 EXTERNAL AUDIBLE and then relay 4, COMMON ALARM will appear.

```

ALARM RELAY ASSIGNMENT
RELAY # : 1 SYSTEM FAULT
< , > : RELAY 0 . . 9 : ZONE ENTER : ACCEPT

```

```

ALARM RELAY ASSIGNMENT
RELAY # : 2 COMMON WARNING
< , > : RELAY 0 . . 9 : ZONE ENTER : ACCEPT

```

```

ALARM RELAY ASSIGNMENT
RELAY # : 3 EXTERNAL AUDIBLE
< , > : RELAY 0 . . 9 : ZONE ENTER : ACCEPT

```

```

ALARM RELAY ASSIGNMENT
RELAY # : 4 COMMON ALARM
< , > : RELAY 0 . . 9 : ZONE ENTER : ACCEPT

```

XIX. When relay 5 is displayed, the system will allow the following choices:

- A. **Change zone #:** Type the new zone number and press ENTER.
- B. **Next relay number:** Press the ← or → key to move through all the Alarm relay assignments.

```

ALARM RELAY ASSIGNMENT
RELAY # : 6 ZONE # : NONE
< , > : RELAY 0 . . 9 : ZONE ENTER : ACCEPT

```

ZGARD CX Controller Operation & Configuration Set Up Menu

XX. Press the MENU key.

The **RELAY LATCHING** menu will appear. The second line of the display shows the current relay number and the current assigned mode of operation. **NOTE:** Relays 1 and 3 have default functions. The first relay 1, SYSTEM FAULT that is non-adjustable. Relay 3, is the EXTERNAL AUDIBLE and cannot be set to Latch. All other relays including 2 and 4 are available with the following choices:

- A. **Change Relay Latch Mode:** Press ENTER to cycle through the available modes (NON-LATCHING or LATCHING) until the desired mode appears.
- B. **Next relay number:** Press the ← or → key to move through all of the relay number assignments.

```

RELAY LATCHING
  RELAY # :      1      NON - LATCHING
< , > : RELAY                ENTER : CHANGE
  
```

XXI. Press the MENU key.

The **RELAY OPERATION** menu will appear. The second line of the display shows the current relay number and the current assigned mode of operation. **NOTE:** The first relay 1, SYSTEM FAULT that is non-adjustable and cannot be set to de-energize. All other relays including 2, 3 and 4 are available with the following choices:

- A. **Change Relay Mode:** Press ENTER to cycle through the available modes (DE-ENERGIZED or ENERGIZED) until the desired mode appears.
- B. **Next relay number:** Press the ← or → key to move through all of the relay assignments.

```

RELAY OPERATION
  RELAY # :      1      NORMALLY ENERGIZED
< , > : RELAY                ENTER : CHANGE
  
```

XXII. Press the MENU key.

XXIII. The **WARNING OFF DELAY** menu will appear. The second line of the display shows the current OFF delay in seconds. The delay may be set to any value from 0 to 600 seconds. The OFF delay is common to all points. The following choice is available:

- A. **Change delay period:** Type the new delay period and press ENTER.

```

WARNING OFF DELAY
                                DELAY :      10 SECONDS
                                0 . . 9 : VALUE                ENTER : ACCEPT
  
```

XXIV. Press the MENU key.

XXV. The **ALARM OFF DELAY** menu will appear. The second line of the display shows the current OFF delay in seconds. The delay may be set to any value from 0 to 600 seconds. The OFF delay is common to all points. The following choice is available:

- A. **Change delay period:** Type the new delay period and press ENTER.

```

ALARM OFF DELAY
                                DELAY :      10 SECONDS
                                0 . . 9 : VALUE                ENTER : ACCEPT
  
```

Section 8

ZGARD CX Controller

Operation & Configuration Set Up Menu

XXVI. Press the MENU key.

XXVII. The **SENSOR CALIBRATION DISPLAY** menu will appear. The second line of the display shows the sensor number and the operating range value. The third line of the display shows of the currently selected sensor concentration level and gas type. While the menu is in calibration menu there is no alarm function or relay action, this screen mode is for indication only.

A. **Go to other point:** Press the ← or → key to move through all of the desired sensor numbers.

```

S E N S O R   D I S P L A Y   ( F O R   C A L I B R A T I O N )
      S E N S O R   #   :       1           R A N G E   :       1 0 0 P P M
      G A S   L E V E L   :           0 P P M       G A S   :   C O
< , > : S E N S O R

```

NOTE: If a sensor should fail during the calibration display mode, the controller will confirm the condition. If the sensor fail condition continues, the status would not change. Once the sensor fail has been corrected, advance to the next sensor number and then scroll back to the suspect sensor again, at which time the system will update the sensor reading. The example below is a Failed sensor event while in the Calibration Display menu screen.

```

S E N S O R   D I S P L A Y   ( F O R   C A L I B R A T I O N )
      S E N S O R   #   :       1           F A I L E D
< , > : S E N S O R

```

XXVIII. Press the MENU key.

XXIX. The **ACCESS CODE** menu will appear. To change the Set-up Menu access code, type in a new code and press ENTER. The access code can be up to 4 digits in length and consist of any combination of numbers from 0 to 9.

```

A C C E S S   C O D E
      N E W   C O D E   :   1 2 3 4
      0 . . 9 : V A L U E           E N T E R : A C C E P T

```

* To cycle through the menu again press the MENU keys until the desired menu screen appears.

** To exit from the Set-up Menu and return to the HOME screen, press RUN. There will be a short delay and the screen will blank-out before the controller resumes back to the normal operation mode.

The ZGARD CX has a Master Access Code, which will initially allow the user to enter the configuration set-up menu. The user may also enter a unique access code. However, the master code will override this code at any time. Keep this code in a safe place so no unauthorized persons will have access to it.

Factory Access Code: 6425

**ZGARD CX Controller
Start-Up Procedure**

When wiring, checking or working within a ZGARD CX Controller, always disconnect the main power to prevent bodily harm.

1. Loosen the locking screws on front of the controller and open the door.
2. Locate the power switch on main circuit board inside controller enclosure.
3. Check all wiring connections are correct and secure.
4. Confirm the RS485 digital remote sensors associated with the controller are appropriately assigned a unique binary address code. **Refer to the appropriate gas sensor manual for further details.**
5. Power up the controller and observe the behavior of the following indicators;
Green LED (SYSTEM OK) Indicator on front panel should be ON.
Red LED (SENSOR FAIL) Indicator on front panel should be OFF.
Amber LED (WARNING) Indicator on front panel should be OFF.
Red LED (ALARM) Indicator on front panel should be OFF.

During initial power up of the controller, the local audible alarm may be activated, press RESET button to silence.

6. Allow the associated remote gas sensors to stabilize. **Refer to the ZGARD S or GS sensor manual for further details.**

Depending on the controller's warning, alarm and delay settings, the display status and the relay action of the controller may vary. Refer to the installation sections of the associated ZGARD CX Controller.

7. Confirm the functionality of the controller and that is operating according to the designed or pre-set configuration settings.
8. Apply a representative sample (at least 60% of the operating range) of the target gas to each of the associated remote gas sensors. This simple test should drive the gas sensors upscale and simulate a warning and or an alarm condition on the controller. **Refer to the ZGARD S or GS sensor manual for further details.**

During this procedure, the audible device may be activated, press RESET button to silence.
The warning and alarm indicators and the corresponding relays may be activated.

Depending on the controller's warning and alarm set-points and delay feature settings, the Warning and Alarm relays may be activated.

Any remote equipment, which may be connected to the controller relay contacts, should now be activated.

9. Remove any test equipment from the sensor and controller.
10. Secure the locking screws on the front door of the ZGARD CX Controller.
11. Secure the locking screws on cover or front door of the associated remote gas sensors.
 - ✓ The initial function test of the ZGARD CX Controller is now completed.

Section 10
ZGARD CX Controller
Parts List

Item	Part Number
RS485 Interface Board, 106713-A	
Relay Card, 106133-A	
LCD Display – CPU, 106638-A	

*** When ordering replacement parts, please state the MSA P/N and S/N of unit.**

 WARNING

Use only genuine MSA replacement parts when performing any maintenance on the ZGARD CX Controller. Failure to do so may seriously impair instrument performance. Repair or alteration of the ZGARD CX Programmable Controller, beyond the scope of these maintenance instructions or by anyone other than authorized MSA service personnel, could cause the product to fail to perform as designed, and persons who rely on this product for their safety could sustain serious personal injury or death.

Disconnect all power source(s) to the ZGARD CX Controller before removing or changing any components.

Mounting Dimensions: 3/16"(4.76mm) Dia. Holes (Qty 4) Centered at 13.0"(330mm) X 10.0"(254mm)
 (Top Two Holes are 3/8"/3/16" Key Holes)

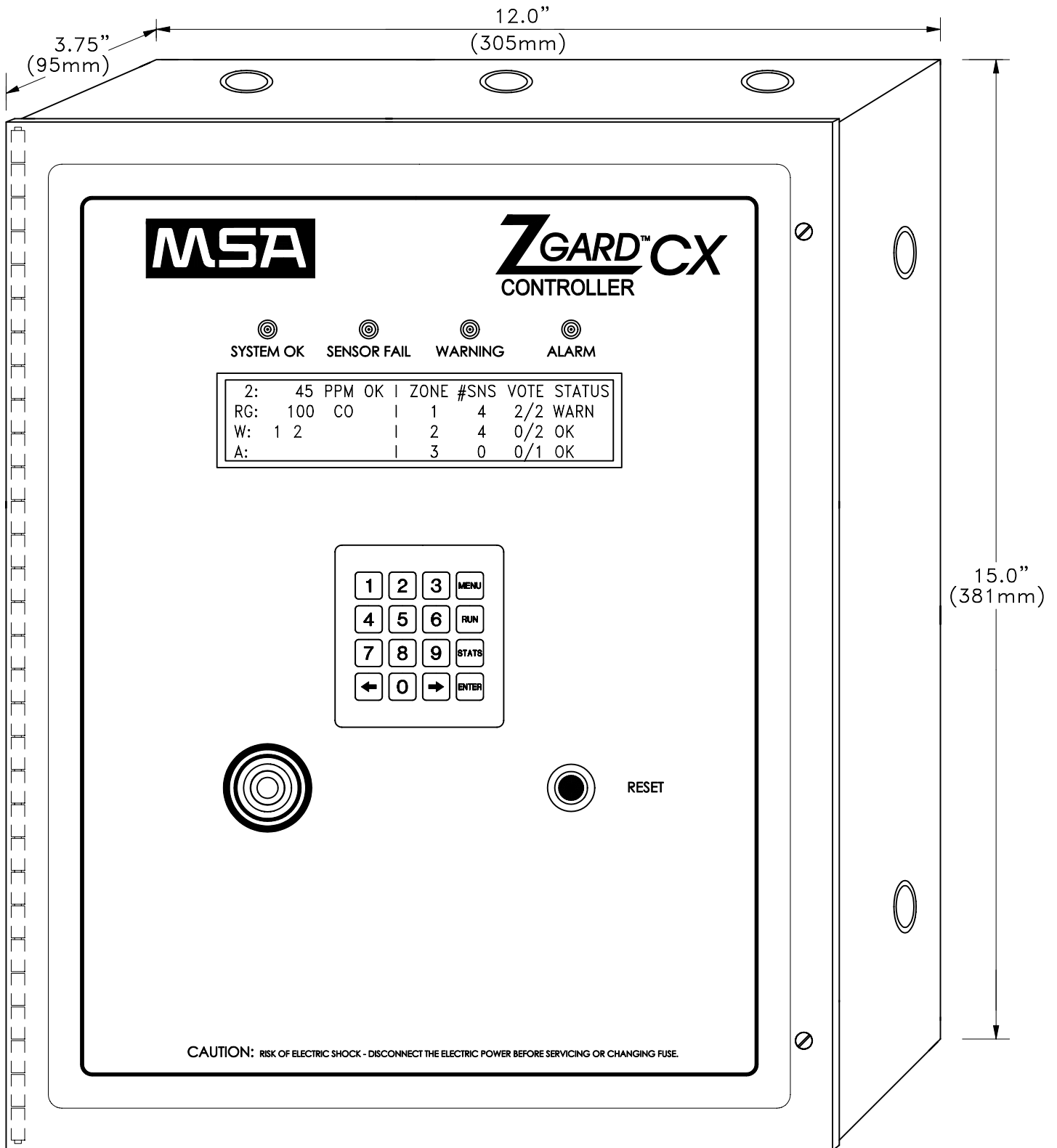

METAL ENCLOSURE
 HINGED SCREW COVER

NOTES:
 1. SYSTEM MAY CHANGE TO IMPROVE PERFORMANCE.

MSA

CHKD: DATE: Jan. 26/05 DRN: KS

**ZGARD CX Programmable Controller
 Enclosure Drawing**

DWG. NO.: 106960 REV. A

INSIDE OF FRONT PANEL

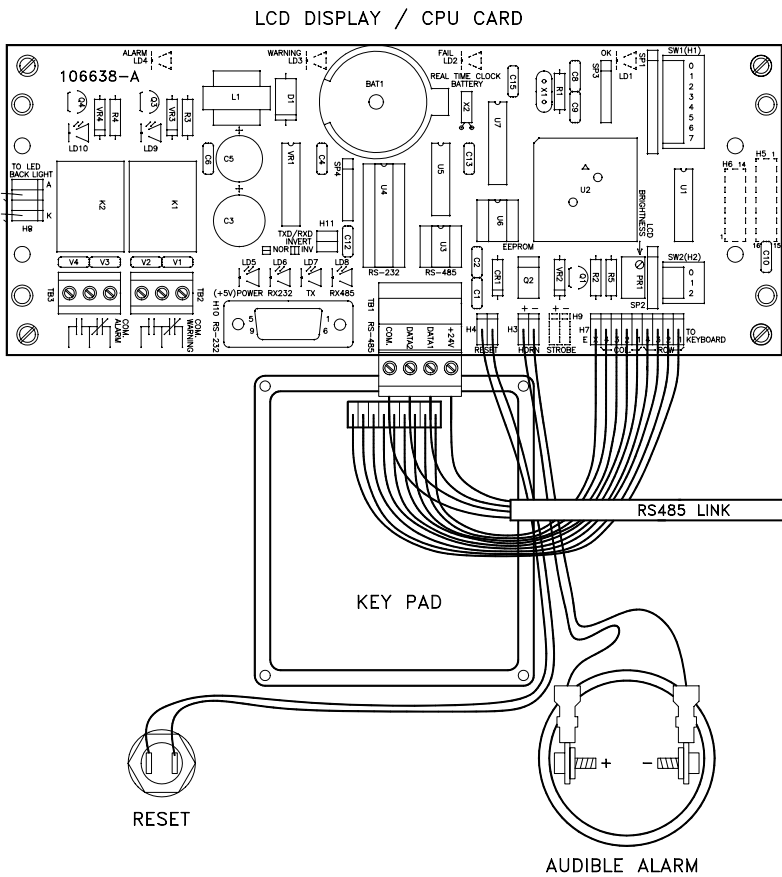

- NOTES:
1. SYSTEM MAY CHANGE TO IMPROVE PERFORMANCE.

BACK PANEL

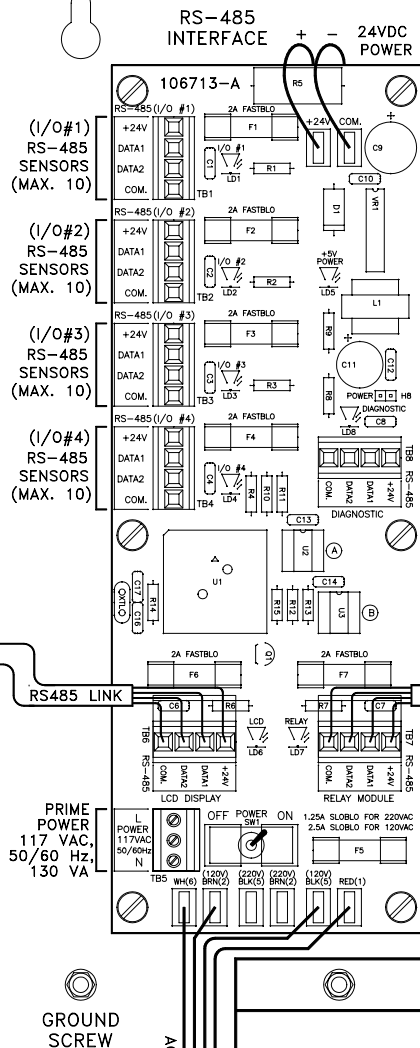

RELAY CARD

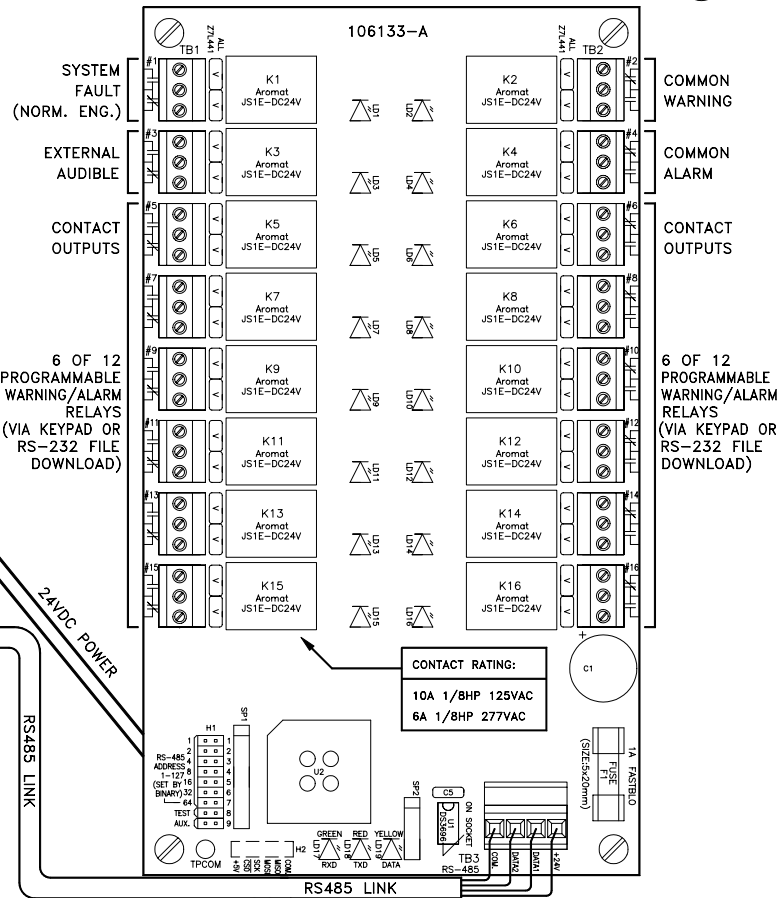

6 OF 12 PROGRAMMABLE WARNING/ALARM RELAYS (VIA KEYPAD OR RS-232 FILE DOWNLOAD)

6 OF 12 PROGRAMMABLE WARNING/ALARM RELAYS (VIA KEYPAD OR RS-232 FILE DOWNLOAD)

24VDC POWER

RS485 LINK

28VDC/4.6A POWER SUPPLY

MSA

CHKD:	DATE: Jan. 26/05	DRN: KS
ZGARD CX Programmable Controller Panel Layout / Connections		
DWG. NO.:	106961	REV. A

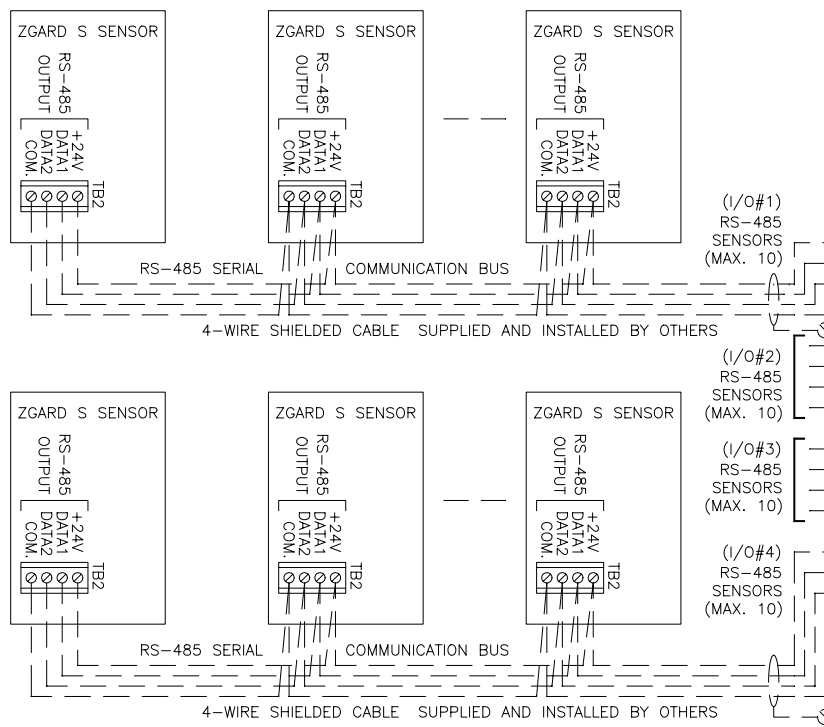

FOR DAISY-CHAIN (SERIES) WIRING OF ZGARD S SENSORS TO THE ZGARD CX AS SHOWN HERE, EACH SENSOR MUST BE UNIQUELY ADDRESSED VIA JUMPERS ON SENSOR CIRCUIT BOARD.

CABLE LENGTH FEET	No. OF SENSORS	4	6	8	10
1 TO 500	AWG #	22	22	22	22
501 TO 1,000	AWG #	22	20	20	20
1,001 TO 1,500	AWG #	20	18	18	16
1,501 TO 2000	AWG #	18	16	16	14

GAUGE (AWG#)	4-WIRE SHIELDED CABLE
22	ALPHA WIRE 5504
20	ALPHA WIRE 5514
18	ALPHA WIRE 5524
16	ALPHA WIRE 5534
14	ALPHA WIRE 5544

NOTES:
 1. DIMENSIONS SHOWN IN INCHES (MILLIMETERS).
 2. SYSTEM MAY CHANGE TO IMPROVE PERFORMANCE.

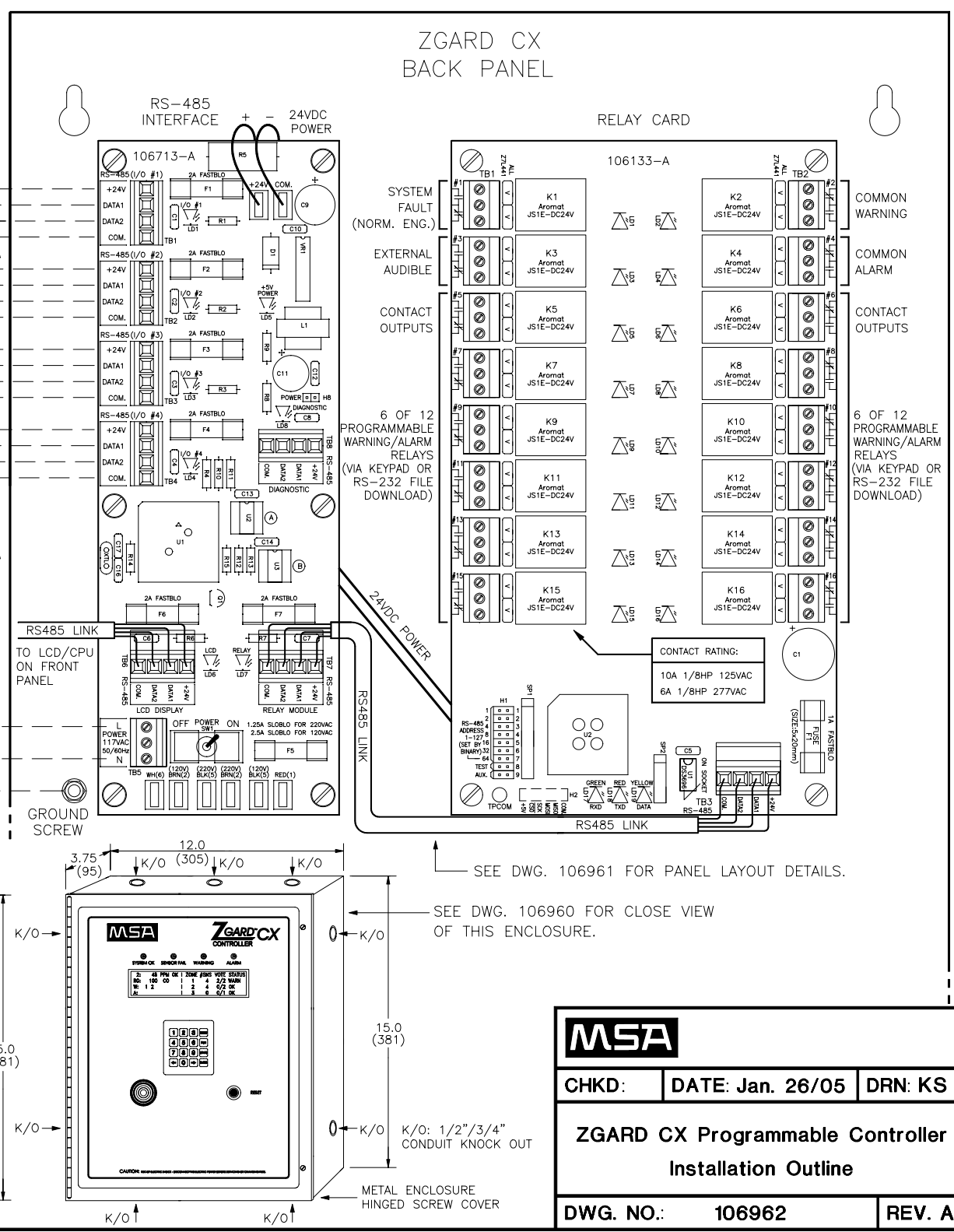
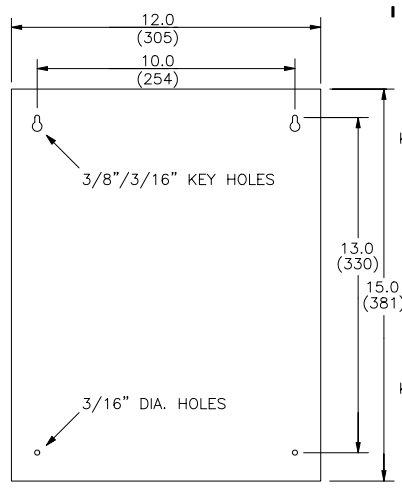

ZGARD CX BACK PANEL

SYSTEM FAULT (NORM. ENG.)
 EXTERNAL AUDIBLE
 CONTACT OUTPUTS
 6 OF 12 PROGRAMMABLE WARNING/ALARM RELAYS (VIA KEYPAD OR RS-232 FILE DOWNLOAD)

RELAY CARD

CONTACT RATING:
 10A 1/8HP 125VAC
 6A 1/8HP 277VAC

SEE DWG. 106961 FOR PANEL LAYOUT DETAILS.

SEE DWG. 106960 FOR CLOSE VIEW OF THIS ENCLOSURE.

CHKD:	DATE: Jan. 26/05	DRN: KS
ZGARD CX Programmable Controller		
Installation Outline		
DWG. NO.:	106962	REV. A