

PremAire® CADET

Air-Line respirator parts list

Manufactured by



MINE SAFETY APPLIANCES COMPANY
PITTSBURGH, PENNSYLVANIA, U.S.A. 15230

Ultravue[®] MM

pressure demand facepiece (NON NFPA)

U.S. Patent Numbers 3,323,135 and 3,348,537

Facepiece Components

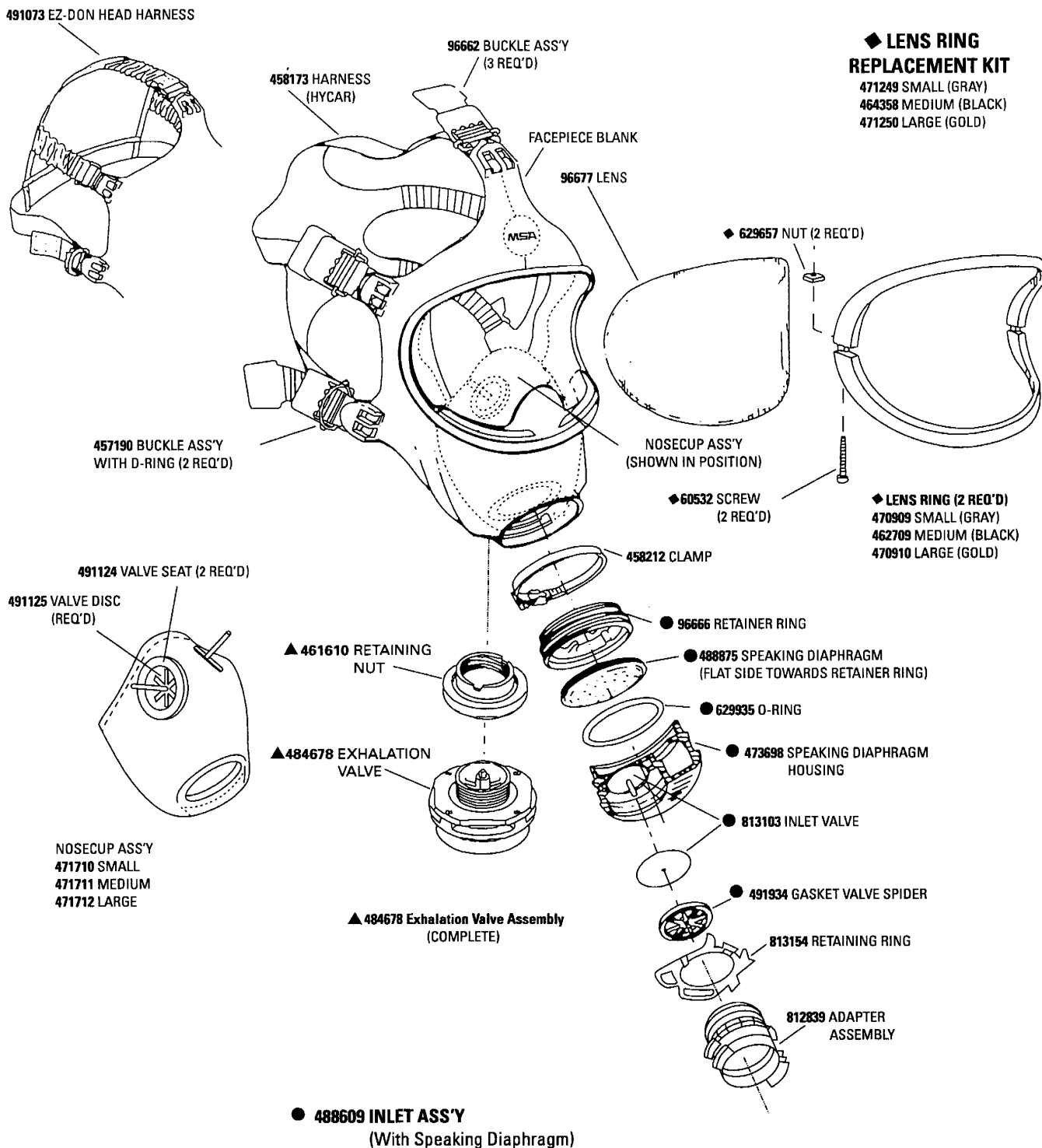

Duo-Twin™ MM

D/DP Facepiece (NON NFPA)

Facepiece Components

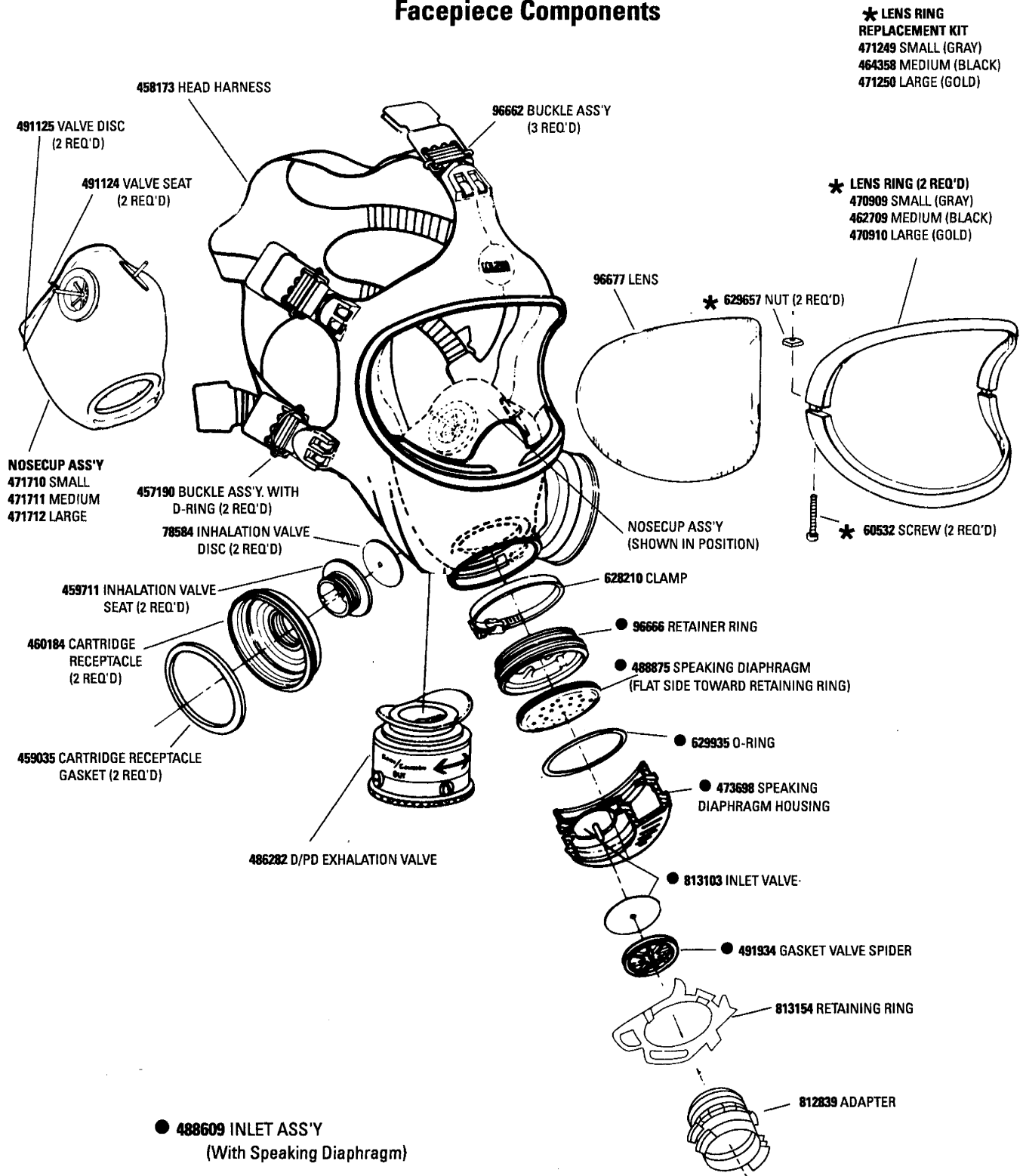

Ultra Elite[®] MM

pressure demand facepiece (NON NFPA)

Facepiece Components

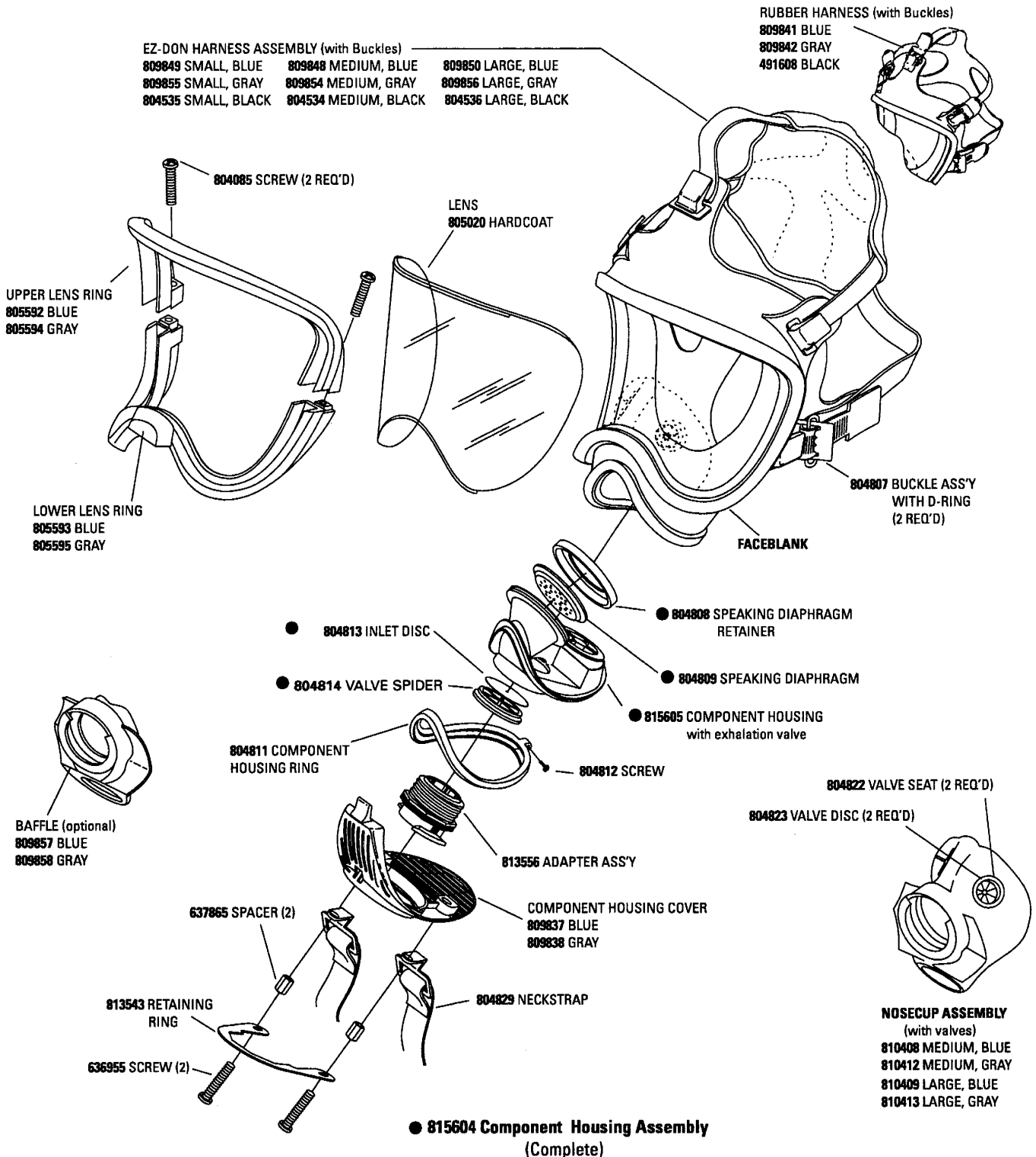

Quick Disconnects Table Chart

LOCKING TYPES

CEJN — Chrome (C)

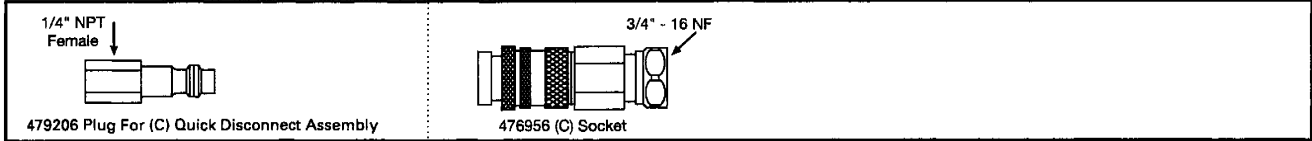

SNAP-TITE — Aluminum (AL)

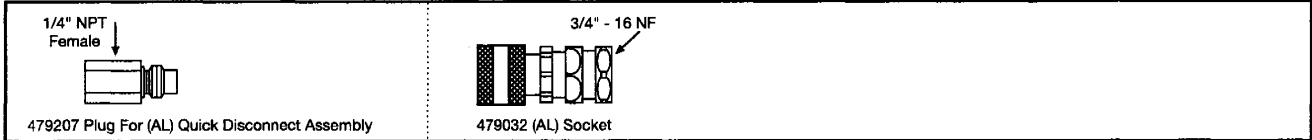

NON-LOCKING TYPES

SNAP-TITE — Aluminum (AL) Brass (BR) Stainless Steel (SST)

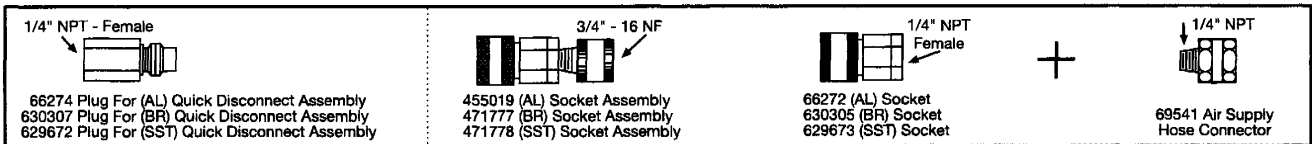

SCHRADER — Steel (S)

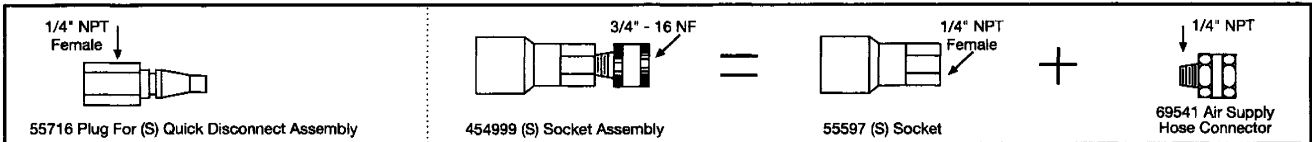

FOSTER — Steel (S) Stainless Steel (SST)

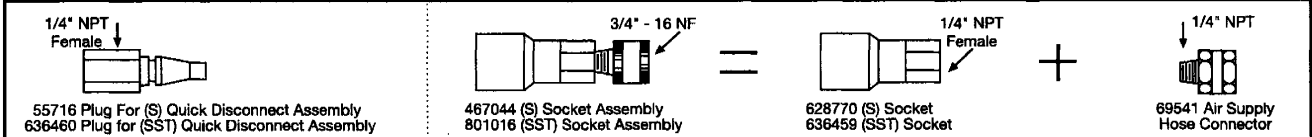

HANSEN — Brass (BR)

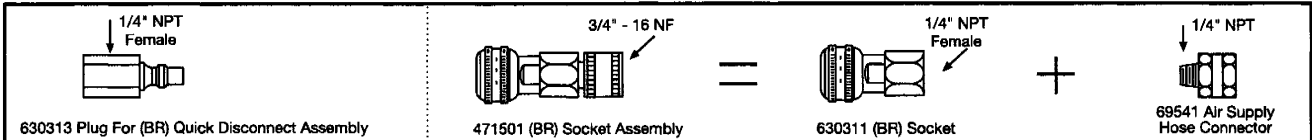

DUFF-NORTON — Brass (BR)

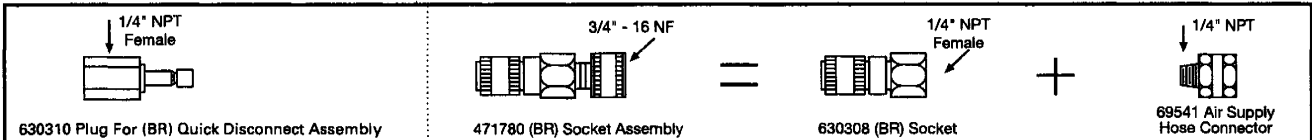

NON-LOCKING TYPES — WITH CHECK VALVE IN PLUG

FOSTER — Brass (BR)

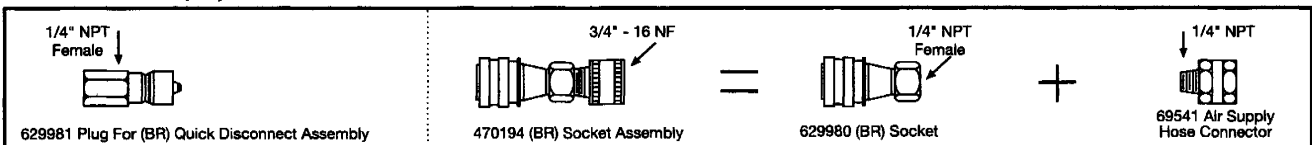

HANSEN — Stainless Steel (SST)

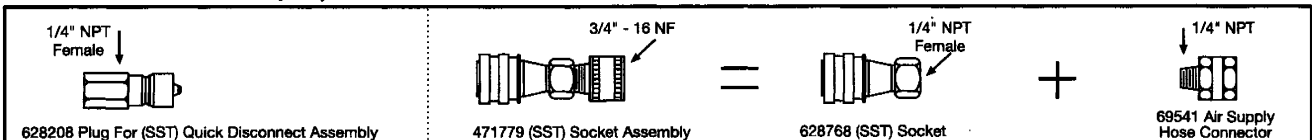

Mask Mounted Regulator Assembly

1/4 Turn Quick Connect
812858 (W/Front Hose)
812859 (W/Rear Hose)

Threaded
496048 (W/Front Hose)
496049 (W/Rear Hose)

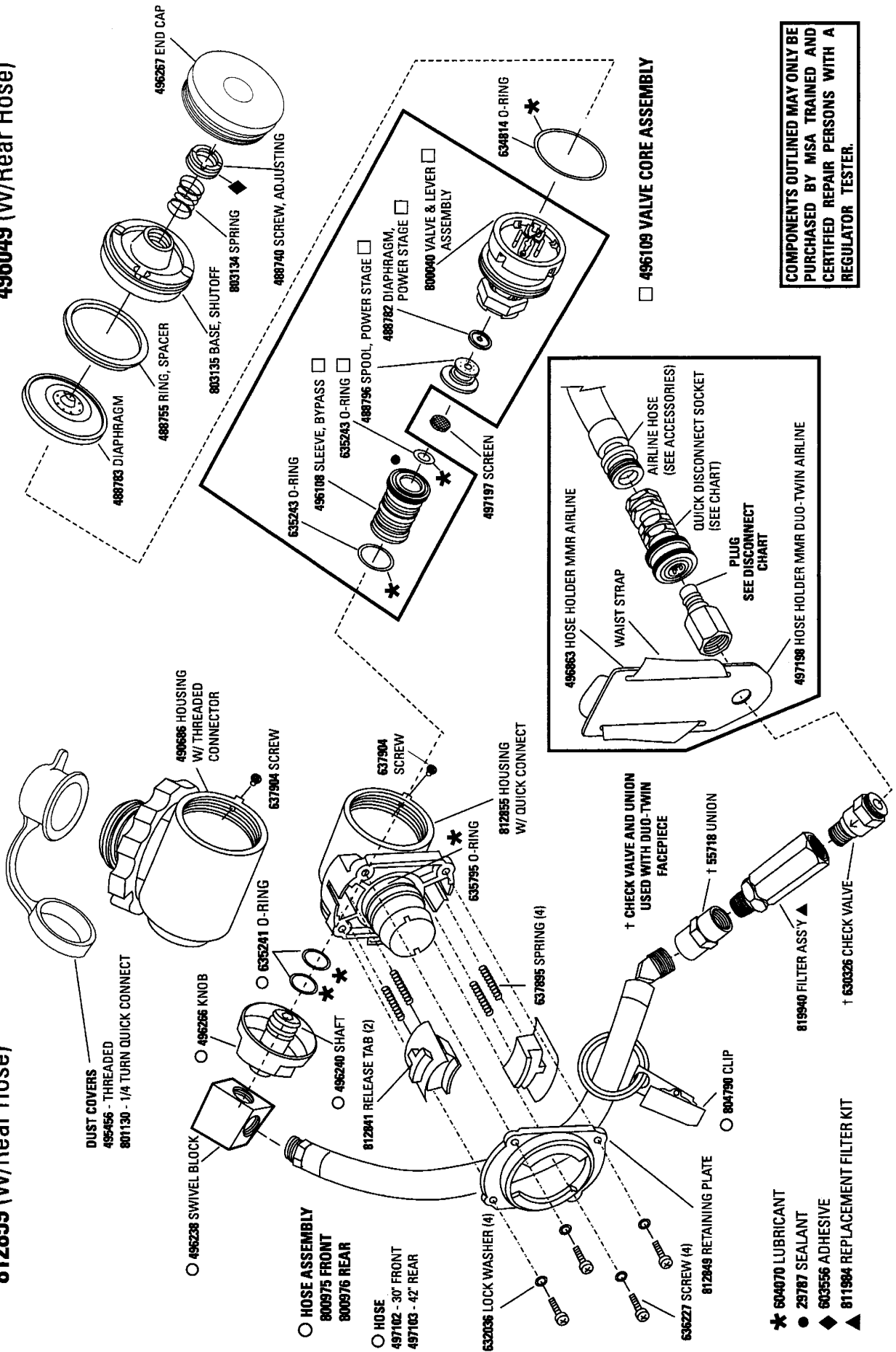

COMPONENTS OUTLINED MAY ONLY BE PURCHASED BY MSA TRAINED AND CERTIFIED REPAIR PERSONS WITH A REGULATOR TESTER.

*** 604070 LUBRICANT**
● 29787 SEALANT
◆ 603556 ADHESIVE
▲ 811984 REPLACEMENT FILTER KIT

Mask Mounted Regulator Assembly

1/4 Turn Quick Connect

812860 (W/Front Hose)

812861 (W/Shut-off Rear Hose)

Threaded

497643 (W/Front Hose)

497644 (W/Shut-off Rear Hose)

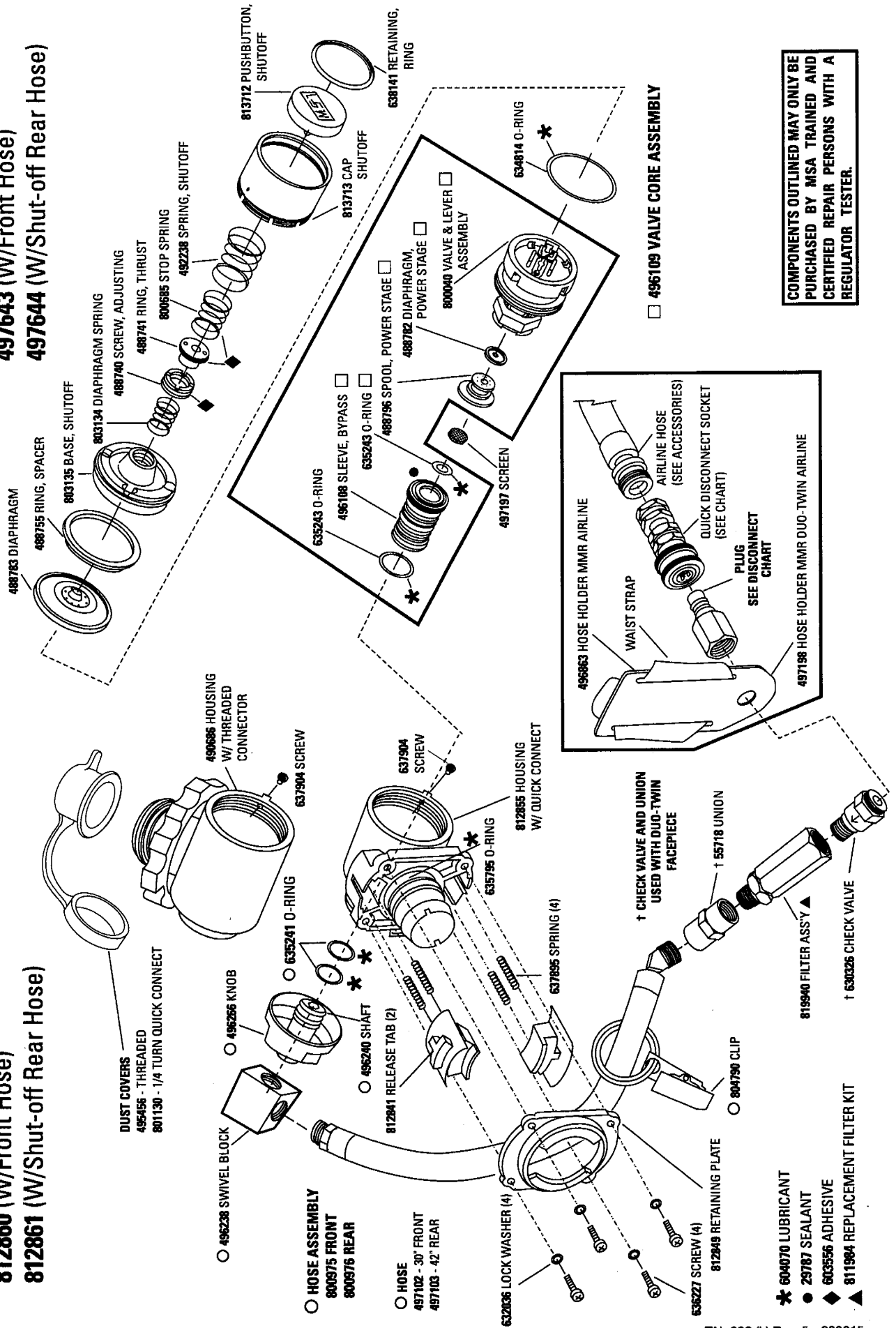

COMPONENTS OUTLINED MAY ONLY BE PURCHASED BY MSA TRAINED AND CERTIFIED REPAIR PERSONS WITH A REGULATOR TESTER.

Mask Mounted Regulator Assembly

1/4 Turn Quick Disconnect (w/Bypass)

813806 (W/Front Hose)

813807 (W/Rear Hose)

Threaded (w/Bypass)

813737 (W/Front Hose)

813738 (W/Rear Hose)

□ 816952 VALVE CORE ASSEMBLY

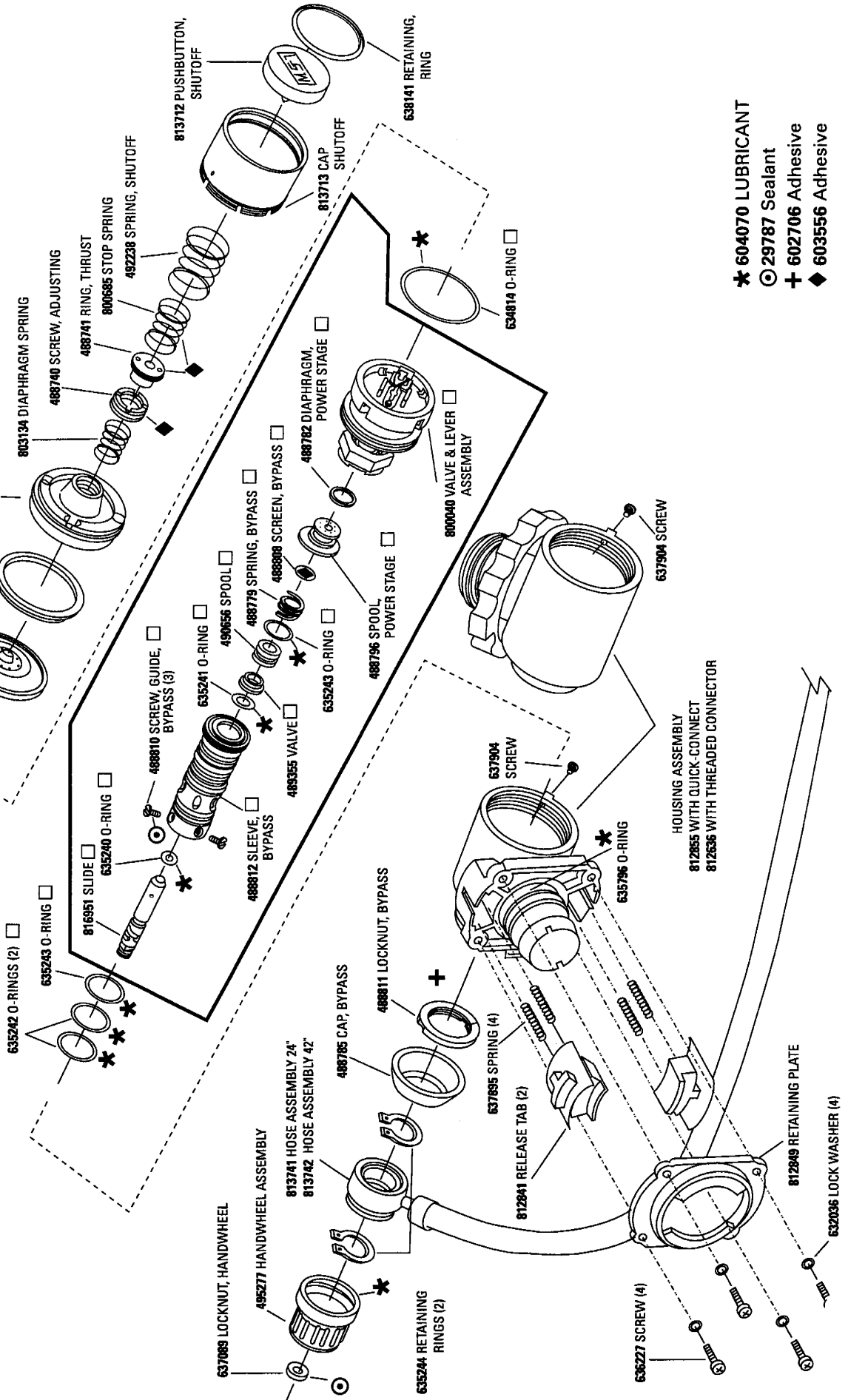

- ★ 604070 LUBRICANT
- ◎ 29787 Sealant
- + 602706 Adhesive
- ◆ 603556 Adhesive

Accessories

The MMR Airline Respirator can be expanded to the PremAire MMR Airline Respirator. See illustrated parts list #800000.

Hose Assemblies

Model P/N	Pt. No.	Hose Length (Feet)	
7-665-1	481071	8	Neoprene
7-665-1	455020	15	Neoprene
7-665-1	455021	25	Neoprene
7-665-1	455022	50	Neoprene
7-664-1	481051	8	Polyvinyl Chloride
7-664-1	471511	15	Polyvinyl Chloride
7-664-1	471512	25	Polyvinyl Chloride
7-664-1	471513	50	Polyvinyl Chloride
7-664-2	484225	100	Polyvinyl Chloride
5-551-1	491513	8	Nylon Coiled*
5-511-1	491514	15	Nylon Coiled*
5-511-1	491515	25	Nylon Coiled*
5-551-1	747043	50	Nylon Coiled*
---	69542	---	Brass Adapter 1/4 Male NPT to 3/4 - 16
			Male UNF
---	628232	---	Brass Adapter 1/4 Female NPT to 3/4 - 16
			Male UNF

*Maximum recommended useable length is one-half actual length.

Instruction Manual pt. no. 800810.

Waist Straps

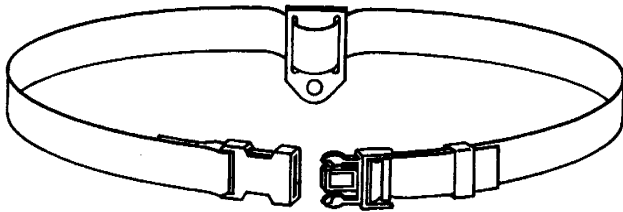

Part No. **9961**
Nylon

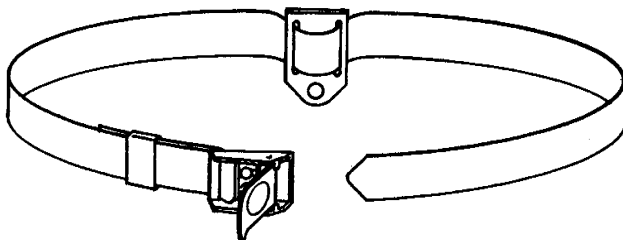

Part No. **492827**
Urethane

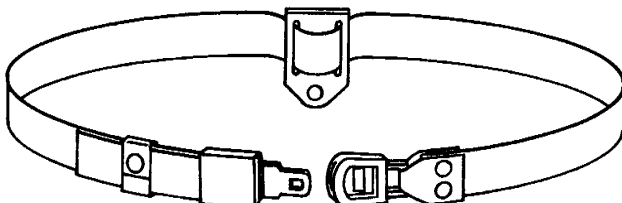

Part No. **802811**
Nomex
Part No. **494030**
Nylon

Accessories

Spectacle Kit

for use with

Ultravue facepiece pt. no. 454819
 Ultra Elite facepiece pt. no. 804638

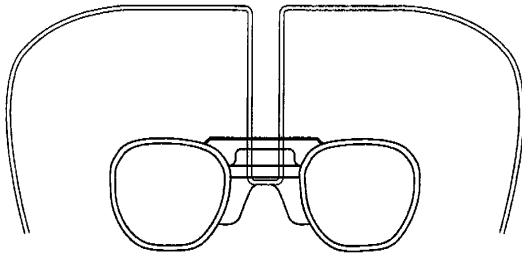

Neckstrap

for use with Ultravue
 and Ultra Elite facepiece

PBI (Ultravue) pt. no. 801156
 PBI (Ultra Elite) pt. no. 804829

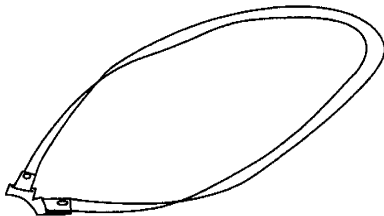

VARI-Clear™

Personal Communication System
 for use in the Ultra Elite facepiece

Refer to operation and maintenance instructions for interface cables.
 (part no. 496915)

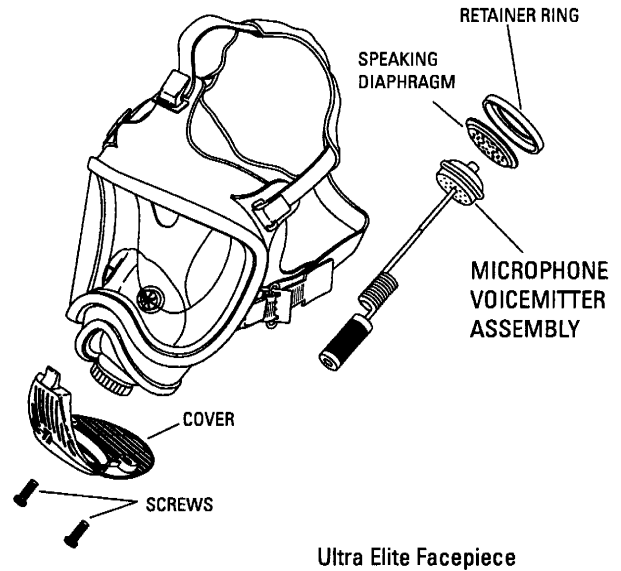

Microphone Conversion Kit:

With Amplifier pt. no. 806168
 Less Amplifier pt. no. 805382

Microphone Conversion Kit:

Radio Interface/VOX/Amplifier pt. no. 496825
 Cable to connect RIV pt. no. 497316

Accessories

VARI-Clear™

Personal Communication System for use in the Ultravue Facepiece

Refer to operation and maintenance instructions for interface cables.
(part no. 496915)

Microphone Conversion Kits

- With Amplifier pt. no. 496917
- Less Amplifier pt. no. 497698

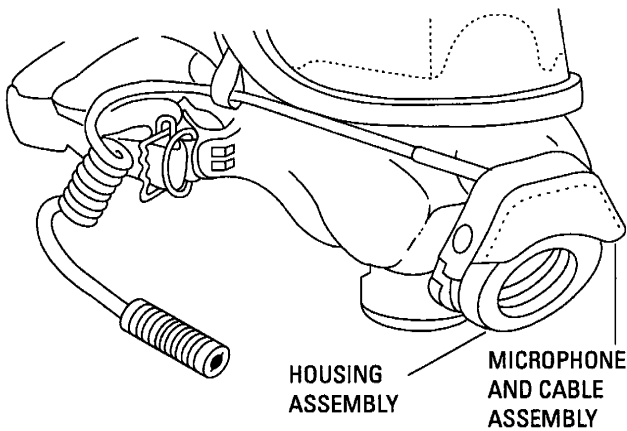

Parts:

- Radio Interface/VOX/Amplifier pt. no. 496825
- Cable to connect RIV pt. no. 497316

ESP®

Communication System Voice Amplification System for the Ultravue® Facepiece

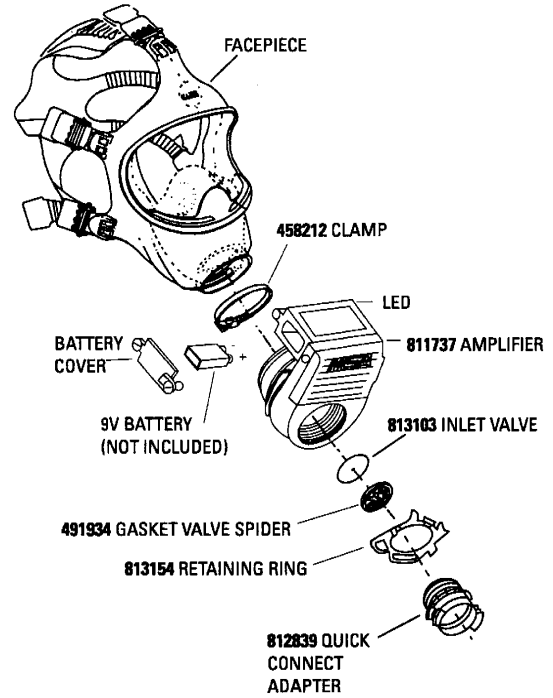

Regulator Clip

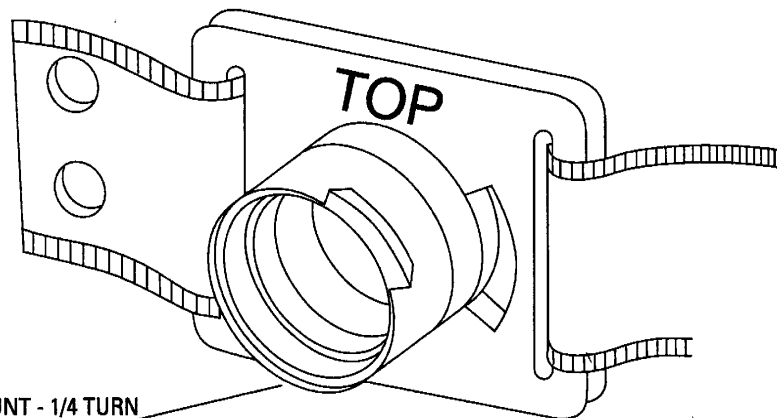

- 812837 BELT MOUNT - 1/4 TURN
- 803713 MOUNT (DIN THREAD)

Assembly Numbers

MMR Air-Line Apparatus					
Part Number Apparatus Assembly Complete		Description	Facepiece		
			Ultravue	Duo-Twin	Ultra Elite
IN CASE	LESS CASE	QUICK DISCONNECT TYPE	●		
496855	496777	Snap Tite Aluminum	●		
496856	496778	Schrader Steel	●		
496857	496779	Foster Steel	●		
496858	496780	None	●		
811011	803701	None - with rear hose	●		
496851	496781	Snap Tite Aluminum		●	
496852	496782	Schrader Steel		●	
496853	496783	Foster Steel		●	
496854	496784	None		●	
None	803702	None - with rear hose		●	
811012	801948	Snap Tite Aluminum		●	Black
811013	801949	Schrader Steel			Black
811014	801950	Foster Steel			Black
811015	801951	None			Black
811016	801952	None - with rear hose			Black
811017	801953	Snap Tite Aluminum			Blue
811018	801954	Schrader Steel			Blue
811019	801955	Foster Steel			Blue
811020	801956	None			Blue
811021	801957	None - with rear hose			Blue
811022	801958	Snap Tite Aluminum			Gray
811023	801959	Schrader Steel			Gray
811024	801960	Foster Steel			Gray
811025	801961	None			Gray
811026	801962	None - with rear hose			Gray